

RICOH

Priport

JP5000

OPERATING INSTRUCTIONS

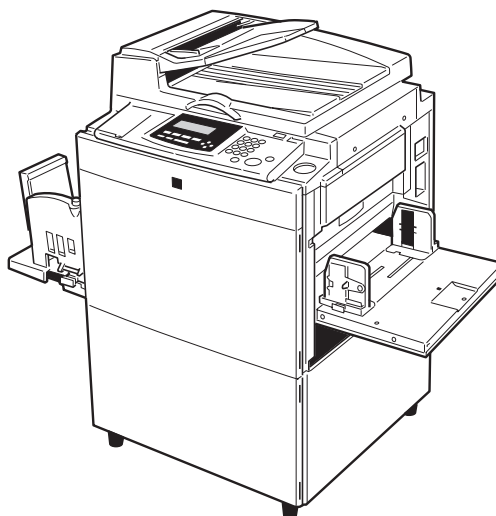

TPEH162N

Read this manual carefully before you use this product and keep it handy for future reference.

For safety, please follow the instructions in this manual.



RICOH COMPANY, LTD.

15-5, 1 chome, Minami-Aoyama, Minato-ku, Tokyo
Telephone: Tokyo 3479-3111

Overseas Affiliates

U.S.A.

RICOH CORPORATION
5 Dedrick Place
West Caldwell, New Jersey 07006
Phone: +1-973-882-2000

The Netherlands

RICOH EUROPE B.V.
Groenelaan 3, 1186 AA, Amstelveen
Phone: +31-(0)20-5474111

United Kingdom

RICOH UK LTD.
Ricoh House,
1 Plane Tree Crescent, Feltham,
Middlesex, TW13 7HG
Phone: +44-(0)181-261-4000

Germany

RICOH DEUTSCHLAND GmbH
Mergenthalerallee 38-40,
65760 Eschborn
Phone: +49-(0)6196-9060

France

RICOH FRANCE S.A.
383, Avenue du Général de Gaulle
BP 307-92143 Clamart Cedex
Phone: +33-(0)1-40-94-38-38

Spain

RICOH ESPAÑA S.A.
Avda. Litoral Mar, 12-14,
08005 Barcelona
Phone: +34-(0)93-295-7600

Italy

RICOH ITALIA SpA
Via della Metallurgia 12,
37139 Verona
Phone: +39-045-8181500

Hong Kong

RICOH HONG KONG LTD.
23/F., China Overseas Building,
139, Hennessy Road,
Wan Chai, Hong Kong
Phone: +852-2862-2888

Singapore

RICOH ASIA PACIFIC PTE.LTD.
260 Orchard Road,
#15-01/02 The Heeren,
Singapore 238855
Phone: +65-830-5888

Introduction

This manual contains detailed instructions on the operation and maintenance of this machine. To get maximum versatility from this machine all operators should carefully read and follow the instructions in this manual. Please keep this manual in a handy place near the machine.

Please read the Safety Information before using this machine. It contains important information related to USER SAFETY and PREVENTING EQUIPMENT PROBLEMS.



Notes:

Some illustrations might be slightly different from your machine.

Certain options might not be available in some countries. For details, please contact your local dealer.



Two kinds of size notation are employed in this manual. With this machine refer to the metric version.

For good print quality, Ricoh recommends that you use genuine Ricoh master and ink.

Ricoh shall not be responsible for any damage or expense that might result from the use of parts other than genuine Ricoh parts in your Ricoh office product.

Power Source

220 – 240V, 50/60Hz, 1.5A or more

Please be sure to connect the power cord to a power source as above. For details about power source, see ⇒ P.202 “Power Connection”.



Declaration of Conformity

“The Product complies with the requirements of the EMC Directive 89/336/EEC and the Low Voltage Directive 73/23/EEC.”

In accordance with IEC 60417, this machine uses the following symbols for the main switch:

I means **POWER ON.**

O means **POWER OFF.**

Safety Information

When using your equipment, the following safety precautions should always be followed.

Safety During Operation

In this manual, the following important symbols are used:

 **WARNING:**
Indicates a potentially hazardous situation which, if instructions are not followed, could result in death or serious injury.

 **CAUTION:**
Indicates a potentially hazardous situation which, if instructions are not followed, may result in minor or moderate injury or damage to property.

⚠ WARNING:

- ***Connect the power cord directly into a wall outlet and never use an extension cord.***
- ***Disconnect the power plug (by pulling the plug, not the cable) if the power cable or plug becomes frayed or otherwise damaged.***
- ***To avoid hazardous electric shock, do not remove any covers or screws other than those specified in this manual.***
- ***Turn off the power and disconnect the power plug (by pulling the plug, not the cable) if any of the following conditions exists:***
 - ***You spill something into the equipment.***
 - ***You suspect that your equipment needs service or repair.***
 - ***Your equipment's cover has been damaged.***

⚠ CAUTION:

- *Protect the equipment from dampness or wet weather, such as rain, snow, and so on.*
- *Unplug the power cord from the wall outlet before you move the equipment. While moving the equipment, you should take care that the power cord will not be damaged under the equipment.*
- *When you disconnect the power plug from the wall outlet, always pull the plug (not the cable).*
- *Do not allow paper clips, staples, or other small metallic objects to fall inside the equipment.*
- *For environmental reasons, do not dispose of the equipment or expended supply waste at household waste collection points. Disposal can take place at an authorized dealer or at appropriate collection sites.*
- *Be careful not to cut yourself on any sharp edges when you reach inside the machine to remove misfed sheets of paper or masters.*
- *Our products are engineered to meet high standards of quality and functionality, and we recommend that you only use the expendable supplies available at an authorized dealer.*

How to Read this Manual

Symbols

In this manual, the following symbols are used:

 **WARNING:**

This symbol indicates a potentially hazardous situation that might result in death or serious injury when you misuse the machine without following the instructions under this symbol. Be sure to read the instructions, all of which are described in the Safety Information section.

 **CAUTION:**

This symbol indicates a potentially hazardous situation that might result in minor or moderate injury or property damage that does not involve personal injury when you misuse the machine without following the instructions under this symbol. Be sure to read the instructions, all of which are described in the Safety Information section.

* The statements above are notes for your safety.

 **Important**

If this instruction is not followed, paper might be misfed, originals might be damaged, or data might be lost. Be sure to read this.

 **Preparation**

This symbol indicates the prior knowledge or preparations required before operating the machine.

 **Note**

This symbol indicates precautions for operation, or actions to take after misoperation.

 **Limitation**

This symbol indicates numerical limits, functions that cannot be used together, or conditions in which a particular function cannot be used.

 **Reference**

This symbol indicates a reference.

[]

Keys that appear on the machine's display panel.

[]

Keys built into the machine's operation panel.

Making Prints

Before making prints using this machine, you have to make a master by pressing the **[Start]** key. When you press the **[Start]** key, the machine scans the original image and makes a master. This procedure describes how to make basic prints.

1 Set your originals in one of the following two ways:

Placing originals on the exposure glass (contact glass)

1 Place a single page face down.

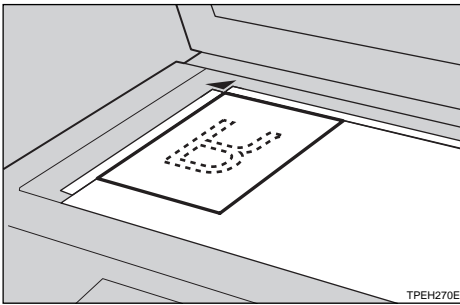

Inserting originals in the optional document feeder

1 Insert a stack of originals face up.

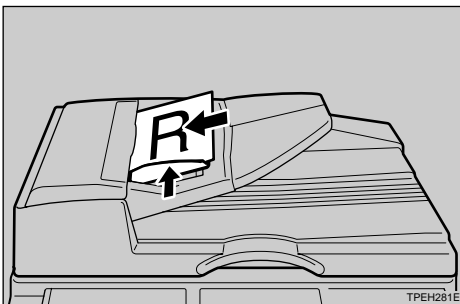

2 Press the **[Start]** key.

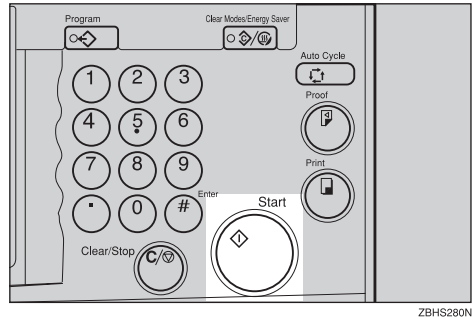

3 Press the **[Proof]** key.

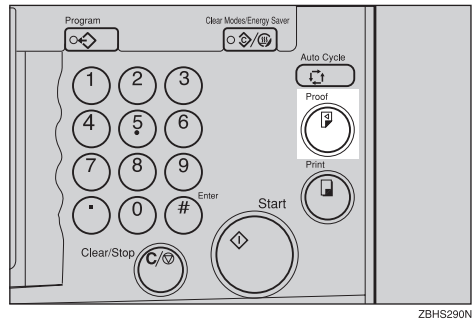

Check the print image.

Reference

For how to change the image position, see ⇒ P.24 "Adjusting the Position of Printed Images".

Ready for Master Making/ Printing			
		A4	0.0mm
Letter	100%	Std.	0.0mm
Original	Ratio	Ppr.Type	Image 

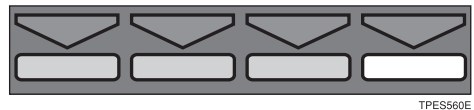

To increase the image density, press the **[◀]** key. See ⇒ P.25 "Adjusting the Image Density of Prints".

To decrease the image density, press the **[▶]** key. See ⇒ P.25 “Adjusting the Image Density of Prints”.

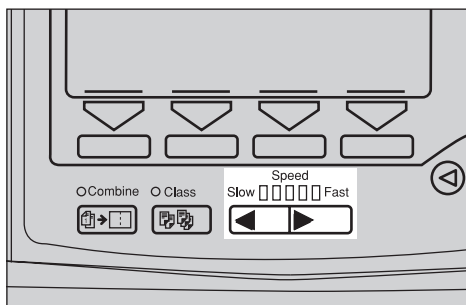

ZBHS300N

4 Enter the desired number of prints with the Number keys.

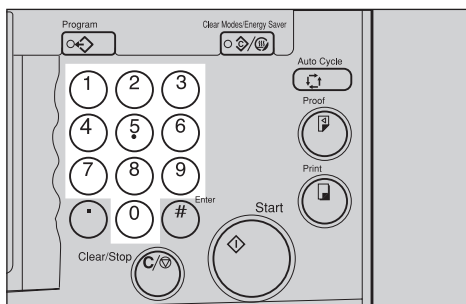

ZBHS310N

5 Press the **[Print]** key.

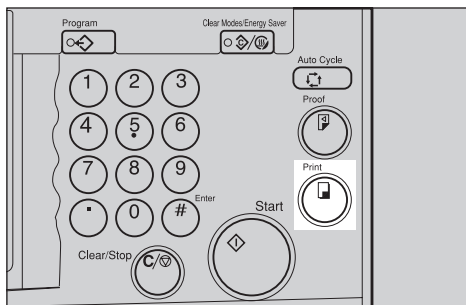

ZBHS320N

When the print job has finished, press the **[Clear Modes/Energy Saver]** key. Previously entered job settings will be cleared.

What You Can do with this Machine

Below is a quick summary of this machine's features and where to look in this manual for more information.

❖ Standard Printing

See ⇒ P.20 "Standard Printing".

❖ Energy Saver Mode

See ⇒ P.23 "Energy Saver Mode — Saving Energy"

❖ Adjusting the Print Image Position

See ⇒ P.24 "Adjusting the Position of Printed Images".

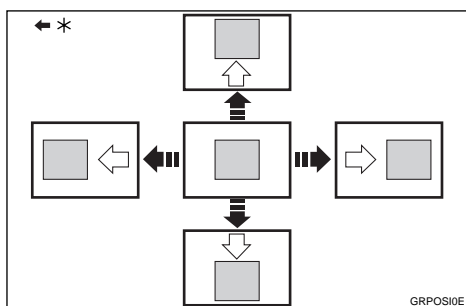

*: Paper feed direction

❖ Adjusting the Print Image Density

See ⇒ P.25 "Adjusting the Image Density of Prints".

❖ Halftone Printing

See ⇒ P.26 "Tint Mode—Halftone Printing".

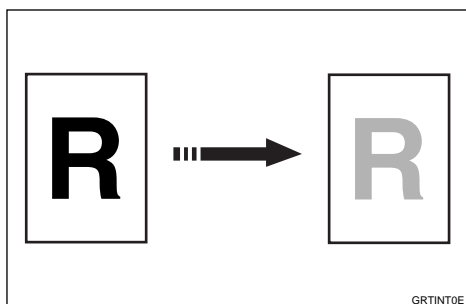

❖ Changing the Printing Speed

See ⇒ P.27 "Changing the Printing Speed".

❖ Reducing and Enlarging Using Preset Ratios

See ⇒ P.29 "Preset Reduce/Enlarge—Reducing and Enlarging Using Preset Ratios".

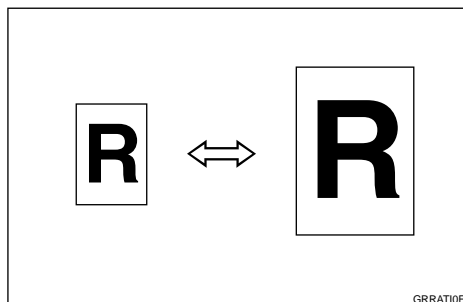

❖ Having the Machine Choose the Reproduction Ratios

See ⇒ P.31 "Auto Magnification—Having the Machine Choose Reproduction Ratios".

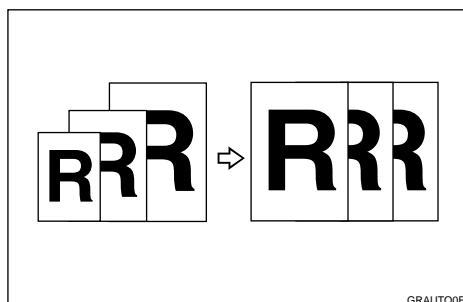

❖ **Reducing and Enlarging in 1% Steps**

See ⇒ P.34 “Zoom—Reducing and Enlarging in 1% Steps”.

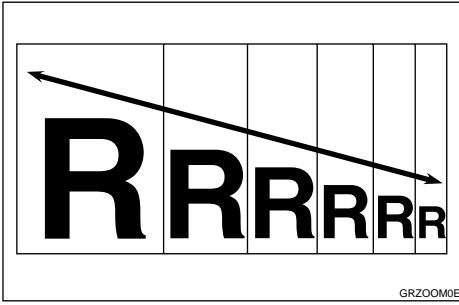

❖ **Stretching and Squeezing the Image in 1% Steps**

See ⇒ P.36 “Directional Magnification (%)—Stretching and Squeezing the Image in 1% Steps”.

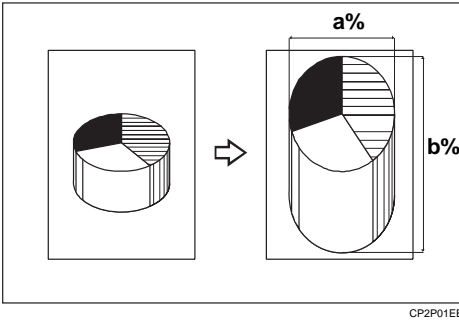

❖ **Stretching and Squeezing the Image into the Copy Area**

See ⇒ P.38 “Directional Magnification (Size)—Stretching and Squeezing the Image into the Copy Area”

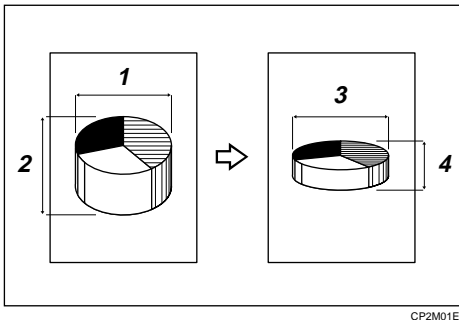

❖ **Erasing centre and Edge Margins**

See ⇒ P.40 “Erasing centre and Edge Margins”.

❖ **Erasing Edge Margins**

See ⇒ P.41 “Edge Erase—Erasing Edge Margins”.

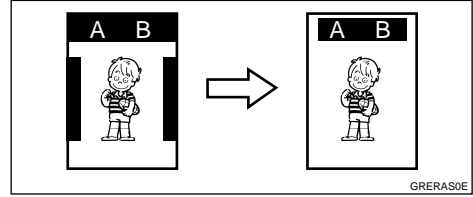

❖ **Printing on Various Kinds of Paper**

See ⇒ P.42 “Printing onto Various Kinds of Paper”.

❖ **Selecting a Mode to Match Your Original**

See ⇒ P.45 “Selecting a Mode to Match Your Original”.

❖ **Saving Ink**

See ⇒ P.48 “Economy Mode—Saving Ink”.

❖ **Making Master and Prints at one Stroke**

See ⇒ P.49 “Auto Cycle—Making Master and Prints in one Operation”.

❖ **Making Variable Numbers of Prints from the Same Original Using All Stored Data**

See ⇒ P.50 “All Class Mode—Making Variable Numbers of Prints from the Same Original Using All Stored Data”.

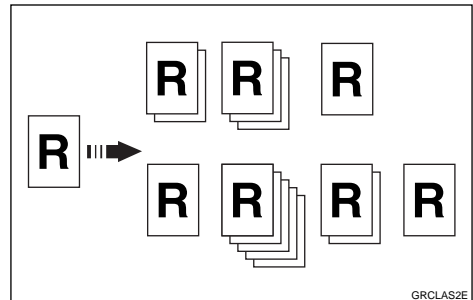

❖ **Making Variable Numbers of Prints from the Same Original Using Stored Data**

See ⇒ P.52 “Auto Class Mode—Making Variable Numbers of Prints from the Same Original Using Stored Data”.

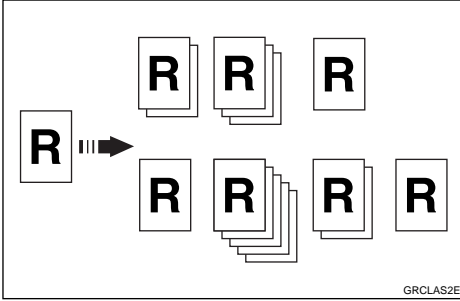

❖ **Making Fixed Numbers of Prints from the Same Original**

See ⇒ P.60 “Class Mode—Making Fixed Numbers of Prints from the Same Original”.

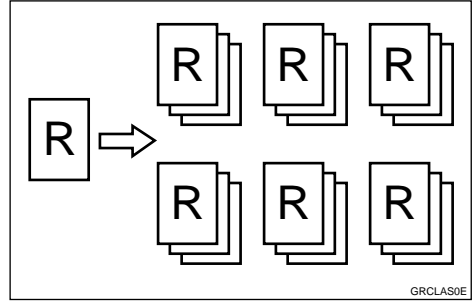

❖ **Making Variable Numbers of Prints from the Same Original**

See ⇒ P.55 “Manual Class Mode with one Original—Making Variable Numbers of Prints from the Same Original”.

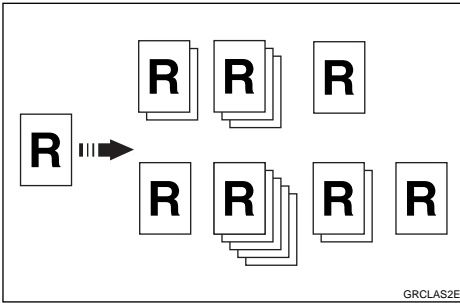

❖ **Combining Originals into one Print**

See ⇒ P.62 “Combine Originals—Combining Originals into one Print”.

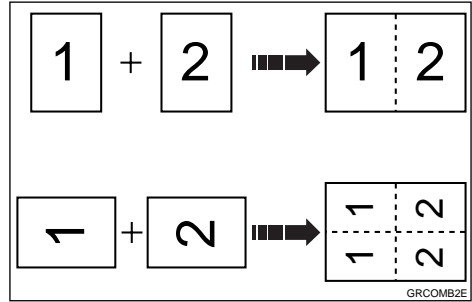

❖ **Making Variable Numbers of Prints from Different Originals**

See ⇒ P.57 “Manual Class Mode with 2 or More Originals—Making Variable Numbers of Prints from Different Originals”.

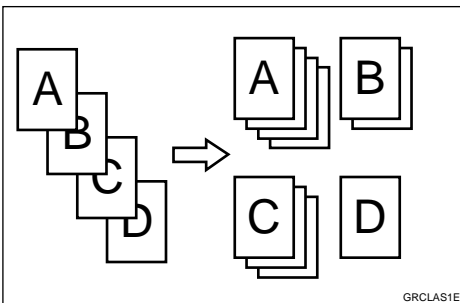

❖ **Having Images Repeated on one Print**

See ⇒ P.67 “Auto Combine Mode—Having Images Repeated on one Print”.

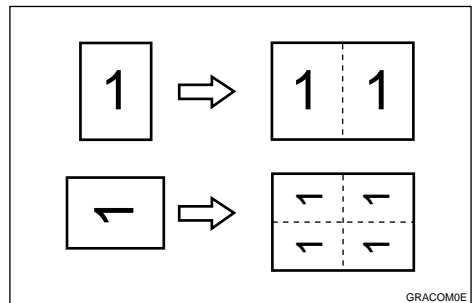

❖ **Skip Feed Printing**

See ⇒ P.69 “Skip Feed Printing”.

❖ **Storing Your Print Settings in Memory**

See ⇒ P.71 “Programs—Storing Your Print Settings in Memory”.

❖ **Printing Confidential Documents**

See ⇒ P.74 *“Security Mode—Printing Confidential Documents”*.

❖ **Regaining the Image Density When the Ink on the Drum Dries**

See ⇒ P.75 *“Quality Start Mode—Regaining Image Density When Drum Ink Dries”*.

❖ **Separating Printing Sets on the Paper Delivery Tray**

See ⇒ P.76 *“Job Separation—Separating Printing Sets in the Paper Delivery Tray”*.

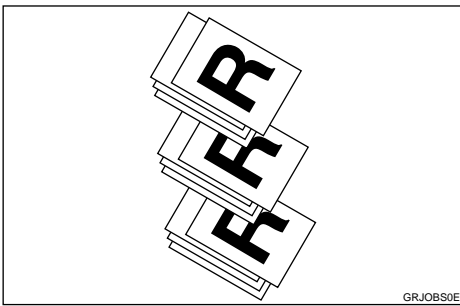

❖ **Conserving the Master**

See ⇒ P.78 *“Conserving the Master”*.

❖ **On Line Printing**

See ⇒ P.79 *“On Line Printing”*.

❖ **Making colour Prints**

See ⇒ P.86 *“Making colour Prints”*.

❖ **Printing in Two colours**

See ⇒ P.88 *“Printing in Two colours”*.

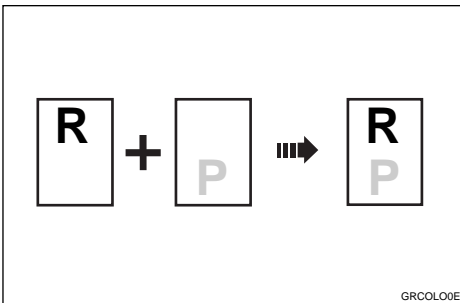

❖ **Rotating Original Images**

See ⇒ P.91 *“Image Rotation—Rotating Original Images”*.

❖ **Make-up Printing**

See ⇒ P.105 *“Make-up Printing”*.

❖ **Merging Images**

See ⇒ P.113 *“Image Overlay—Merging Images”*.

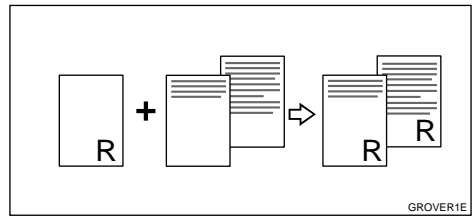
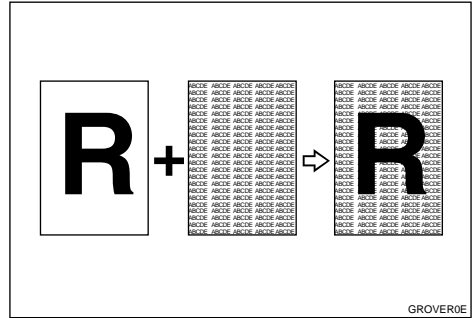

❖ **Having the Date Stamped on Prints**

See ⇒ P.115 *“Date Stamp—Having the Date Stamped on Prints”*.

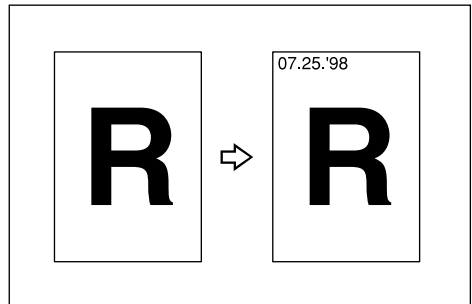

❖ **Having Page Numbers Stamped on Prints**

See ⇒ P.117 *“Page Stamp—Having Page Numbers Stamped on Prints”*.

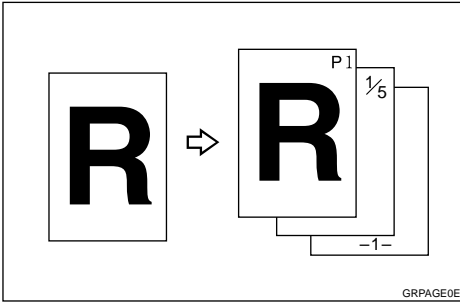

❖ **Having Preset Messages Stamped on Prints**

See ⇒ P.120 *“Stamp—Having Preset Messages Stamped on Prints”*.

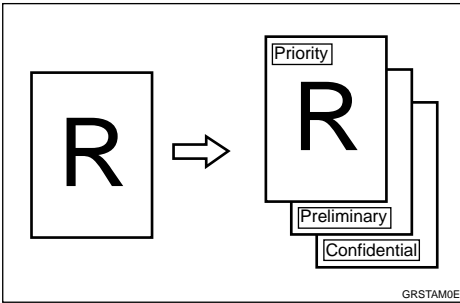

❖ **Having Custom Messages Stamped on Prints**

See ⇒ P.122 *“User Stamp—Having Custom Messages Stamped on Prints”*.

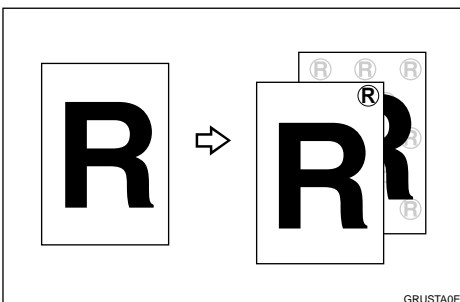

❖ **Combining Originals into one Print with the Memory Board**

See ⇒ P.124 *“Memory Combine—Combining Originals into one Print with the Memory Board”*.

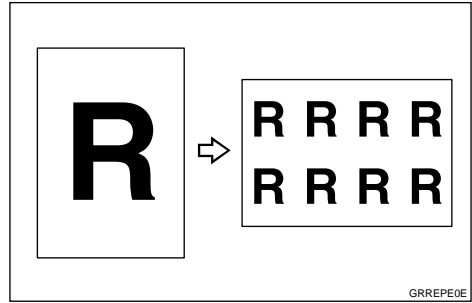
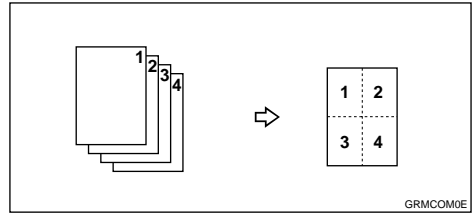

❖ **Sorting Prints into Sets**

See ⇒ P.133 *“Sort/Class Sort”*.

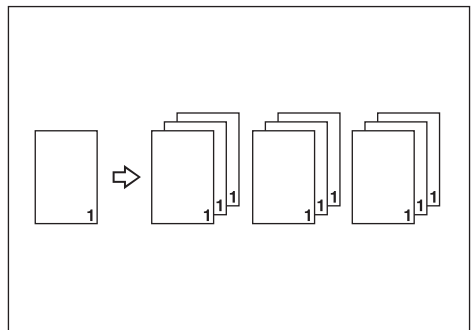
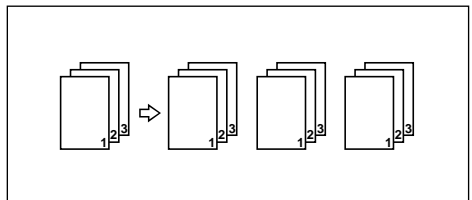

TABLE OF CONTENTS

Machine Exterior	1
Machine Interior	2
Options	4
Operation Panel	6
Keys.....	6
Indicators.....	8
Panel Display	9
Panel Display Layout.....	10

1. Operation

Print Paper	11
Originals	13
Preparation For Printing	15
Loading Paper.....	15
Setting Up The Paper Delivery Tray.....	16
Entering a User Code to Use the Machine	19
Standard Printing	20
Removing Prints.....	21
Energy Saver Mode — Saving Energy	23
Adjusting the Position of Printed Images	24
Adjusting the Image Density of Prints	25
Before Making a Master.....	25
After Making a Master.....	25
Tint Mode—Halftone Printing	26
Changing the Printing Speed	27
Stopping a Multi-print Run	28
Stopping a Multi-print Run to Print Another Original.....	28
Changing the Number of Prints Entered and Checking Completed Prints..	28
Preset Reduce/Enlarge—Reducing and Enlarging Using Preset Ratios...	29
Auto Magnification—Having the Machine Choose Reproduction Ratios...	31
Zoom—Reducing and Enlarging in 1% Steps	34
Directional Magnification (%)—Stretching and Squeezing the Image in 1% Steps	36
Directional Magnification (Size)—Stretching and Squeezing the Image into the Copy Area	38
Erasing centre and Edge Margins	40
Edge Erase—Erasing Edge Margins	41

Printing onto Various Kinds of Paper	42
Printing onto Thick Paper.....	42
Printing onto Thin Paper	42
Printing onto Envelopes	42
Printing onto Special Kinds of Paper.....	43
Selecting a Mode to Match Your Original	45
Letter/Photo Mode Printing	45
Photo Mode Printing.....	46
Pencil Mode Printing	47
Economy Mode—Saving Ink	48
Auto Cycle—Making Master and Prints in one Operation	49
All Class Mode—Making Variable Numbers of Prints from the Same Original Using All Stored Data	50
Auto Class Mode— Making Variable Numbers of Prints from the Same Original Using Stored Data	52
Manual Class Mode with one Original—Making Variable Numbers of Prints from the Same Original	55
Manual Class Mode with 2 or More Originals—Making Variable Numbers of Prints from Different Originals	57
Class Mode—Making Fixed Numbers of Prints from the Same Original...	60
Combine Originals—Combining Originals into one Print	62
Auto Combine Mode—Having Images Repeated on one Print	67
Skip Feed Printing	69
Programs—Storing Your Print Settings in Memory	71
Storing a Program	71
Recalling a Program.....	72
Protecting a Program	72
Removing Program Protection	73
Security Mode—Printing Confidential Documents	74
Quality Start Mode— Regaining Image DensityWhen Drum Ink Dries ...	75
Using Quality Start Manually	75
Job Separation—Separating Printing Sets in the Paper Delivery Tray...	76
Conserving the Master.....	78
On Line Printing.....	79

2. Optional Functions

Optional Document Feeder	81
Originals	81
Setting Originals in the Document Feeder	82
Combine Printing with the Document Feeder	83
Manual Class Mode with Two or More Originals Using the Document Feeder ...	84

Colour Printing Using the Optional Colour Drum	86
Making colour Prints.....	86
Changing the Colour Drum Unit.....	86
Printing in Two colours.....	88
Changing the Drum Size.....	90
Printing Area (At 23°C/73°F, 65% RH).....	90
Master Cut Length.....	90
Image Rotation—Rotating Original Images	91
Make-up Printing Features	93
Main Features	93
Make-up Modes for Designated Areas.....	93
Make-up Modes for Outside Designated Areas	95
Background Patterns.....	96
Command Sheets for Make-Up Printing.....	98
Command Sheets	98
Making a Command Sheet.....	99
Command Sheets and Finished Prints.....	104
Make-up Printing	105
Make-up Printing with the Optional Document Feeder.....	107
Make-up Samples	110
Image Overlay—Merging Images.....	113
Date Stamp—Having the Date Stamped on Prints	115
Page Stamp—Having Page Numbers Stamped on Prints	117
Stamp—Having Preset Messages Stamped on Prints.....	120
User Stamp—Having Custom Messages Stamped on Prints.....	122
Memory Combine—Combining Originals into one Print with the Memory Board	124
Combining Several Single-sided Originals onto one Single-sided Print ...	124
Repeat—Repeating an Image over the Entire Print.....	129
Sort/Class Sort.....	133
Sort—Sorting into Sets (123, 123, 123)	134
Class Sort.....	135

3. Combination Chart

Combination Chart	137
--------------------------------	------------

4. User Tools

Accessing the User Tools.....	139
User Tools Menu.....	141
1. System	141
2. Set Operation Mode	143
3. Initial Setting.....	144
4. Mode Setting	146
5. Stamp.....	151
6. Set User Code(s)	154
User Tool Menus in Detail.....	156
1-8 Time Setting.....	156
3-4 Reproduction Ratio	156
3-5 Class Enter No.....	157
3-9 Margin Erase Area	158
4-11 No. of Skip Feed	159
4-14 No. of Q.start.....	160
4-19 Type of Paper	161
5-4 Stamp Position.....	162
5-7 Position (User)	163
5-8 Regist. (User).....	165
5-11 Position (Date)	166
5-14 Position (Page)	167
5-15 Make/Chg. Pattern	168
6-1 Check Counter	169
6-2 Reset Counters	170
6-4 Chg. User Code	170
6-5 Del. User Code	171

5. What to do If Something Goes Wrong

If Your Machine does not Operate as You Want.....	173
If You Cannot Make Prints as You Want	176
Combine Originals Mode.....	176
Loading Paper.....	177
🔧 Clearing Misfeeds.....	178
"🔧 + A" Paper Misfeed in the Paper Feed Section.....	178
"🔧 + A + B" Paper Misfeed in the Paper Feed Section	179
"🔧 + B" Paper or Master Wrapped around the Drum	180
"🔧 + C" Paper Misfeed in the Paper Exit Section.....	182
"🔧 + D" Master Misfeed in the Master Feed Section.....	182
"🔧 + D + B" Master Misfeed in the Master Feed Section	183
"🔧 + B + E" Master Misfeed in the Master Eject Section	184
"🔧 + E" Master Misfeed in the Master Eject Section	184
"🔧 + P" Original Misfeed Occurs When Using the Optional Document Feeder ...	185
"🔧 + R1" Paper Misfeed in the Optional Sorter	186
"🔧 + R2" Paper Misfeed in the Optional Sorter	187
"🔧 + R3" "🔧 + R4" Paper Misfeed in the Optional Sorter	187

- When the Open Cover/Unit Indicator (☐*) Lights..... 188**
- When the Add Ink Indicator (☒) Lights..... 189**
- When the Master End Indicator (☒) Lights..... 191**
- When the Master Eject Indicator (☒) Lights..... 193**
- When Other Indicators are Lit 194**
- When Prints are not Delivered in a Neat Stack..... 195**
 - When Printing on Small Size Paper 195
 - When the Machine Cannot Detect the Paper Size..... 195
- Poor Printing..... 196**
 - Dirty Background..... 196
 - Black Lines/Stained Prints 198
 - Faint Prints 198

6. Remarks

- Do's and Don'ts 199**
- Where to Put Your Machine..... 201**
 - Environment 201
 - Power Connection 202
 - Machine Clearance 202
- Maintaining Your Machine 204**
 - Cleaning the Main Frame 204
 - Cleaning the Optional Document Feeder 205

7. Specifications

- Main Frame..... 207**
- Document Feeder (Option) 211**
- Sorter (Option)..... 212**
- Consumables 213**
- INDEX..... 214**

Machine Exterior

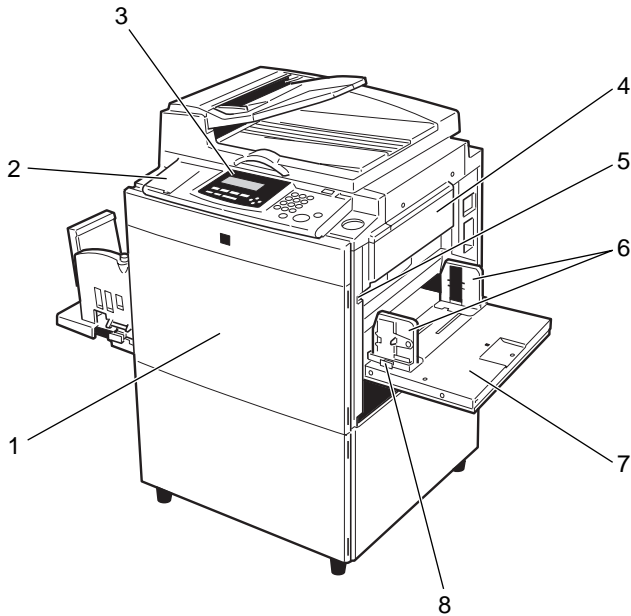

TPEH162E

1. Front door

Open to access the inside of the machine.

2. Flip up cover

Flip up to access the keys underneath.

3. Operation panel

See ⇒ P.6 "Operation Panel".

4. Master tray

Open this unit when installing the master.

5. Paper feed tray down key

Press to lower the Paper feed tray.

6. Paper feed side plates

Prevent paper being fed skewed.

7. Paper feed tray

Set paper here.

8. Paper feed side plates knob

Use to move the side plates.

Machine Interior

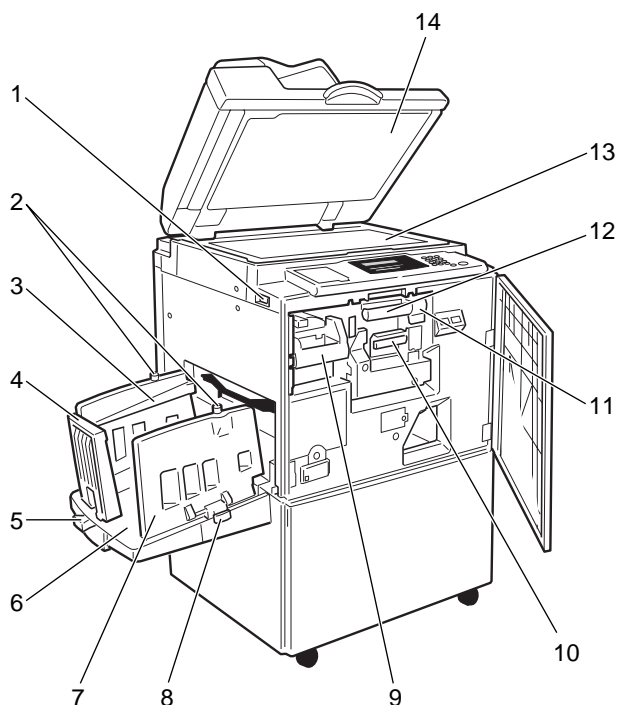

TPEH260E

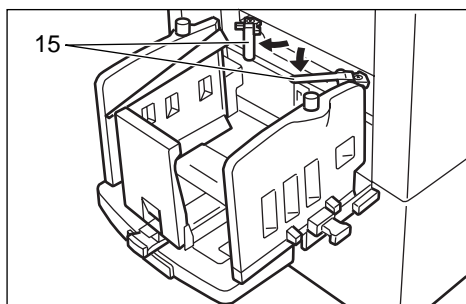

1. Main switch

Use to turn the power on or off.

2. Paper alignment wing knobs

Use to lift or lower the paper alignment wings.

3. Paper alignment wings

Lift or lower the wings depending on the type of paper being used.

4. Paper delivery end plate

This plate aligns the leading edge of prints.

5. Paper delivery end plate knob

Use to move the end plate.

6. Paper delivery tray

Completed prints are delivered here.

7. Paper delivery side plates

These plates align the prints on the paper delivery tray.

8. Paper delivery side plate knobs

Use to move the side plates.

9. Handle E1

Use to pull out the master eject unit.

10. Ink holder

Set the ink cartridge in this holder.

11. Drum unit lock lever B1

Lower to unlock and pull out the drum unit.

12. Drum unit

The master is wrapped around this unit.



13. Exposure glass (Contact glass)

Position originals here face down for printing.

14. Platen cover or document feeder (option)

Lower this cover over an original on the exposure glass (contact glass).

15. Trailing edge guides

Swing out these guides when you use A4, 8¹/₂" × 11"  or B5  paper.

Options

❖ Document feeder

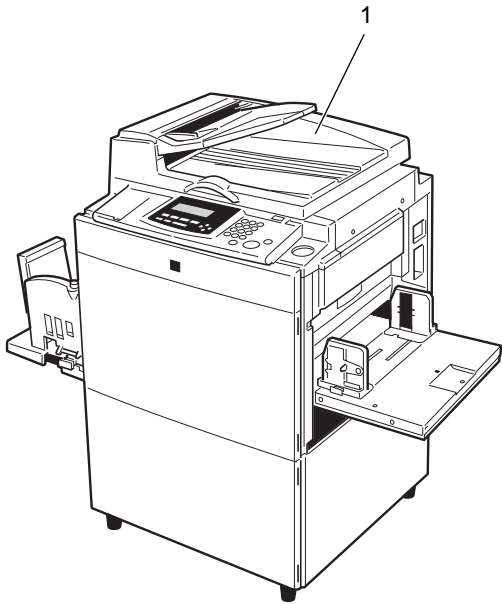

TPEH163E

1. Document Feeder

❖ Sorter

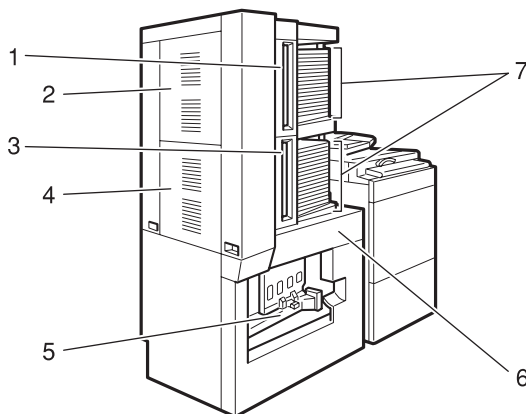

ZBHP050E

- 1. Upper tray cover
- 2. Upper side cover
- 3. Lower tray cover
- 4. Lower side cover

- 5. Paper delivery tray
- 6. Front cover
- 7. Trays

 **Note**

Other options:

- Colour Drums: A3, 11" × 17" drum
- Colour Drums: A4, 8¹/₂" × 11" drum
- Key Counter
- Memory Board
- PC Controller

Operation Panel

Keys

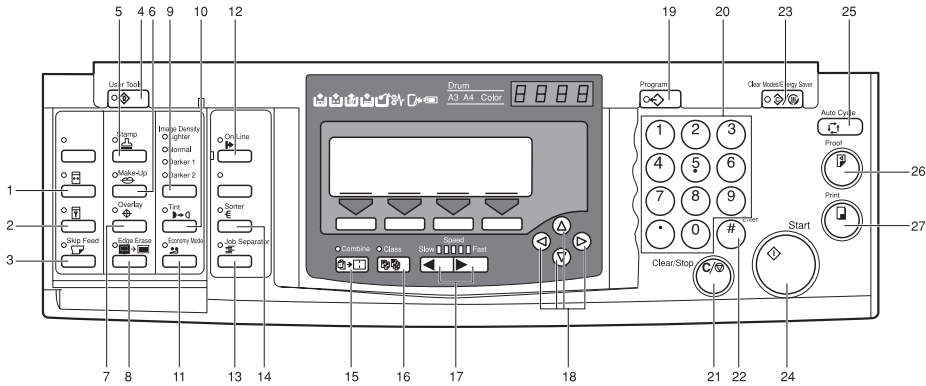

ZBHS330A

1. **Quality Start** key

See ⇒ P.75 “Quality Start Mode—Regain-
ing Image DensityWhen Drum Ink Dries”.

2. **Security** key

See ⇒ P.74 “Security Mode—Printing Con-
fidential Documents”.

3. **Skip Feed** key

Press to select skip feed printing. See ⇒
P.69 “Skip Feed Printing”.

4. **User Tools** key

Press to change the default settings to
meet your requirements.

5. **Stamp** key

Press to select the optional Stamp func-
tion. See ⇒ P.115 “Date Stamp—Having
the Date Stamped on Prints”, ⇒ P.117 “Page
Stamp—Having Page Numbers Stamped on
Prints”, ⇒ P.120 “Stamp—Having Preset
Messages Stamped on Prints”, ⇒ P.122
“User Stamp—Having Custom Messages
Stamped on Prints”.

6. **Make-Up** key

Press to select the optional Make-up
function. See ⇒ P.105 “Make-up Printing”.

7. **Overlay** key

Press to select the optional Image Over-
lay mode. See ⇒ P.113 “Image Overlay—
Merging Images”.

8. **Edge Erase** key

Press to select Edge Erase mode. See ⇒
P.41 “Edge Erase—Erasing Edge Margins”.

9. **Image Density** key

Press to make prints darker or lighter. See
⇒ P.25 “Adjusting the Image Density of
Prints”.

10. **Tint** key

Press to reproduce tinted images. See ⇒
P.26 “Tint Mode—Halftone Printing”.

11. **Economy Mode** key

Press to save ink. See ⇒ P.48 “Economy
Mode—Saving Ink”.

12. **On Line** key

See ⇒ P.79 “On Line Printing”

13. **Job Separator** key

See ⇒ P.76 “Job Separation—Separating
Printing Sets in the Paper Delivery Tray”.

14. **Sorter** key

Press to select the optional Sort or Class
Sortfunction.

15. [Combine] key

Press to combine originals onto 1 print. See ⇒ P.62 *“Combine Originals—Combining Originals into one Print”*, ⇒ P.124 *“Memory Combine—Combining Originals into one Print with the Memory Board”*, ⇒ P.67 *“Auto Combine Mode—Having Images Repeated on one Print”*.

16. [Class] key

Press to select All Class, Auto Class, Manual Class, or Class mode. See ⇒ P.50 *“All Class Mode—Making Variable Numbers of Prints from the Same Original Using All Stored Data”*, ⇒ P.52 *“Auto Class Mode—Making Variable Numbers of Prints from the Same Original Using Stored Data”*, ⇒ P.55 *“Manual Class Mode with one Original—Making Variable Numbers of Prints from the Same Original”*, ⇒ P.57 *“Manual Class Mode with 2 or More Originals—Making Variable Numbers of Prints from Different Originals”*, ⇒ P.60 *“Class Mode—Making Fixed Numbers of Prints from the Same Original”*.

17. [◀][▶] keys (Speed keys)

Press to adjust the printing speed. See ⇒ P.25 *“Adjusting the Image Density of Prints”*, ⇒ P.27 *“Changing the Printing Speed”*.

18. [◀][▶][△][▽] keys

Press to shift the image forward, backward, right, or left. See ⇒ P.24 *“Adjusting the Position of Printed Images”*.

Also use to highlight items you wish to select on the panel display.

19. [Program] key

Press to input or recall programs. See ⇒ P.71 *“Programs—Storing Your Print Settings in Memory”*.

20. Number keys

Press to enter the desired number of prints and data for selected modes.

21. [Clear/Stop] key

Press to stop printing.

22. [#] key

Use to enter data in selected modes.

23. [Clear Modes/Energy Saver] key

Press to clear any previously entered job settings.

24. [Start] key

Press to make a master.

25. [Auto Cycle] key

Use to process the master and make prints in one operation. See ⇒ P.49 *“Auto Cycle—Making Master and Prints in one Operation”*.

26. [Proof] key

Press to make proof prints.

27. [Print] key

Press to start printing.

Indicators

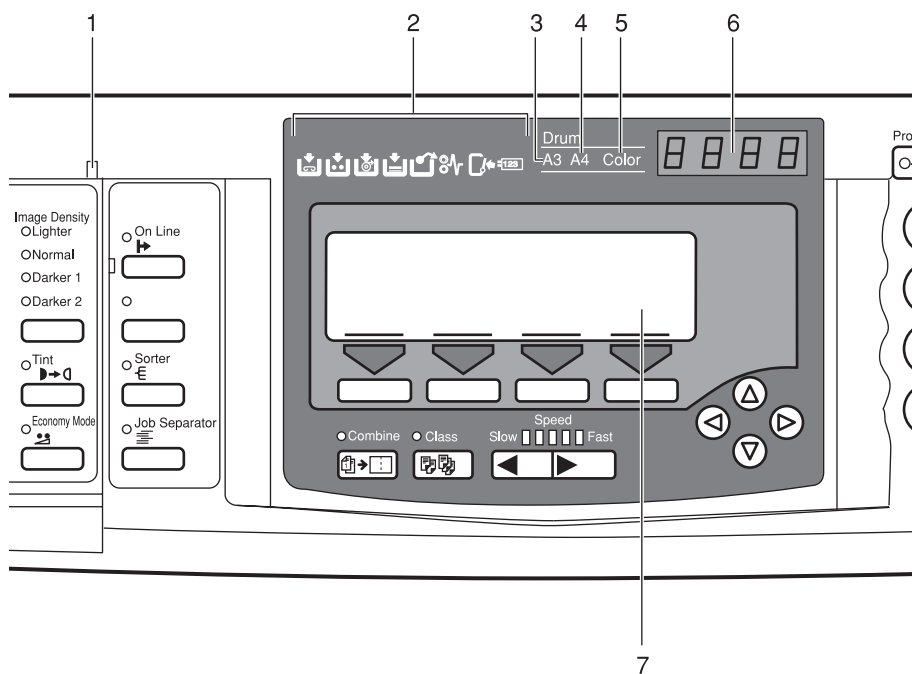

ZBHS350A

1. Special feature indicator

Lights to indicate that special features have been selected. To access the special features, lift up the cover on the left side of the operation panel.

2. Monitor indicators

These indicators light to inform you of the status of the machine. See ⇒ P.173 "If Your Machine does not Operate as You Want".

3. A3/11" × 17" drum indicator

Lights when the A3, 11" × 17" drum unit is installed. See ⇒ P.90 "Changing the Drum Size".

4. A4/8¹/₂" × 11" drum indicator

Lights when the A4, 8¹/₂" × 11" drum unit is installed. See ⇒ P.90 "Changing the Drum Size".

5. colour drum indicator

Lights when the colour drum unit is installed. See ⇒ P.86 "Colour Printing Using the Optional Colour Drum".

6. Counter

Displays the number of prints entered. While printing, it shows the number of prints remaining.

7. Panel display

See ⇒ P.9 "Panel Display".

Panel Display

The panel display shows the machine status, error messages, and function menus.

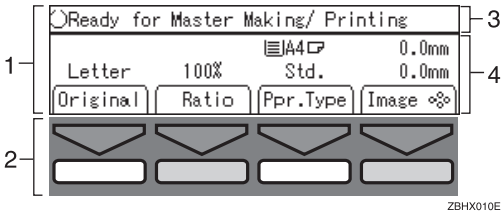

1. Items for the selected function.

2. These keys correspond to the selectable items shown above them on the panel display. To select an item

shown on the panel display, press the key directly below it.

3. Machine status or messages.

4. Items which can be selected.

Important

Do not apply a strong shock or force of about 30N (about 3kgf) or more to the panel display or it could be damaged.

Note

When you select an item on the panel display, it is highlighted (e.g. **Auto**). Items shown grayed-out (e.g. **OK**) cannot be selected.

Common panel display items:

[OK]	Confirms selection of a function or enters a value.
[Cancel]	Cancels selection of a function or input of a value and returns to the previous display.
[Prev.][Next]	When there are too many items to fit on the panel display, use these keys to move between pages.
[<][>][△][▽][←][→]	Press to highlight items you wish to select on the panel display.
[Select]	Selects a value.
[Exit]	Returns to the previous display.

Panel Display Layout

The basic elements used on the panel display are shown below. Understanding their meaning helps you exploit this machine's features quickly and easily.

❖ Sample display when selecting the [Original] key

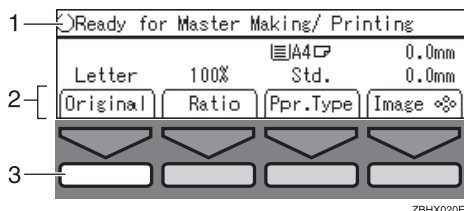

1. Machine status or message.

2. Available functions.

3. Illustrations of displays in this manual show the next key to be pressed whitened out.

E.g. ↓ means "Press the [Original] key".

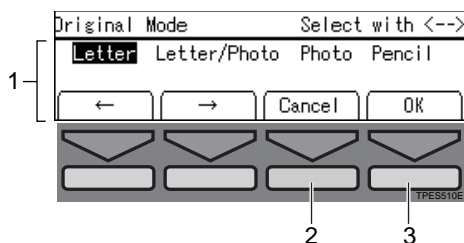

1. Available functions.

2. Cancels the settings and returns to the previous display.

3. Confirms the settings.

1. Operation

Print Paper

The following limitations apply to tray:

	Paper Size		Paper Weight
	Metric	Inch	
Paper feed tray	A3 ☐, B4 ☐, A4 ☐ ☐, B5 ☐ ☐, A5 ☐, B6 ☐, A6 ☐, Others (Vertical: 70 - 297mm, Horizontal: 148 - 432mm)	11" × 17" ☐, 8 ¹ / ₂ " × 14" ☐, 8 ¹ / ₂ " × 11" ☐ ☐, 5 ¹ / ₂ " × 8 ¹ / ₂ " ☐ ☐, Others (Vertical: 2.76" - 11.7", Horizontal: 5.83" - 17")	47.1 - 209.3g/m ² , 12.5 - 55.6 lb

Non-recommended paper:

- Roughly cut paper
- Paper of different thickness in the same stack
- Envelopes heavier than 85g/m², 22 lb.
- Folded, curled, creased, or damaged paper
- Torn paper
- Slippery paper
- Rough paper
- Paper with any kind of coating (such as carbon)
- Short grain paper
- Thin paper that has low stiffness
- Paper that is prone to generate a lot of paper dust
- Grained paper loaded with the direction of the grain perpendicular to the feed direction
- Certain types of long thin envelopes e.g. international mail envelopes

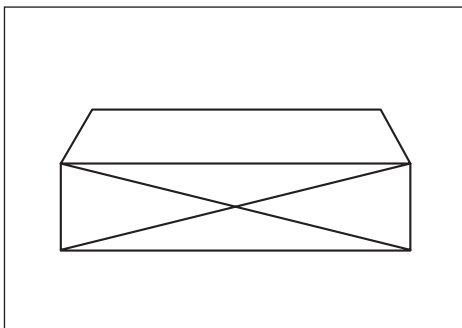

ZADY140E

- The following types of envelopes:

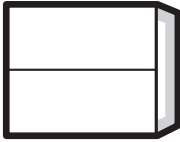
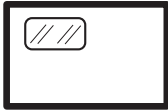
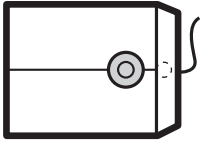
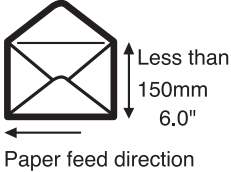
Envelopes with glue or gum	Envelopes with windows	Envelopes with round tags	Open envelopes
			 <p>Less than 150mm 6.0"</p> <p>Paper feed direction</p>

If you make a print on rough grain paper, the copy image might be blurred.

You can use A3 (297 × 420mm) or 11" × 17" originals or printing paper. When you want to print the entire image of an A3, 11" × 17" original, select Reduce mode because the maximum print areas are as follows:

- Metric version: 290 × 409mm, 11.4" × 16.1"
- Inch version: 290 × 419mm, 11.4" × 16.4"

When you use A3, 11" × 17" and 209.3g/m², 55.6 lb paper, slow the printing speed down to setting 1, 2, or 3.

Important

- ❑ Correct curls in the paper before setting it in the machine. When you cannot correct the paper curl, stack the paper with the curl face down or face up as shown in the illustration. If paper is curled, it might wrap around the drum or stains might appear.

Originals

The machine can detect the following sizes of original set on the exposure glass (contact glass):

Metric version	A3☐, B4☐, A4☐☐, B5☐☐
Inch version	11" × 17"☐, 8 ¹ / ₂ " × 14"☐, 8 ¹ / ₂ " × 11"☐☐

If the machine cannot detect the original size properly, select the area to copy with the **[Edge Erase]** key. See ⇒ P.41 “Edge Erase—Erasing Edge Margins”. The machine may not detect the original size properly when:

- Originals contain index tabs.
- Originals are OHP transparencies or are translucent.
- Originals are dark.
- Originals contain solid images.
- Originals are of sizes other those listed above.

If you do not lift the platen cover more than 30cm, 12" when you set another original, the machine might not detect the next original size correctly.

The maximum original size you can set on the exposure glass (contact glass) is 304.8 × 432mm, 12" × 17".

If you use originals that have bold letters or solid images at the leading edges, you might get prints with dirty edges. In this case, set the original face down with the widest margin toward the paper delivery tray or raise the printing speed.

Set originals after correction fluid and ink have completely dried. Not taking this precaution could mark the exposure glass (contact glass) and cause marks to be printed.

In most situations, set originals as shown below.

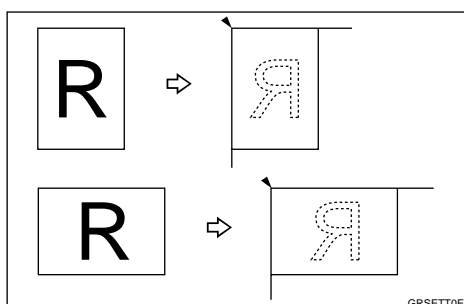

When you have an optional memory board and the original is set in a different direction from the print paper, the machine automatically rotates the original image by 90° to match the print paper direction.

The first 10mm, 0.4", of the leading edge and the last 2mm, 0.08", of the trailing edge cannot be printed. Make sure the leading edge margin is at least 10mm, 0.4", and the trailing edge margin is at least 2mm, 0.08".

1

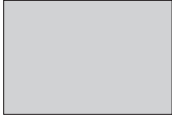
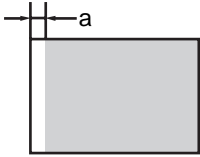
Original	Print
	

$a = 10\text{mm}, 0.4''$

Preparation For Printing

Loading Paper

- 1 Carefully open the paper feed tray.

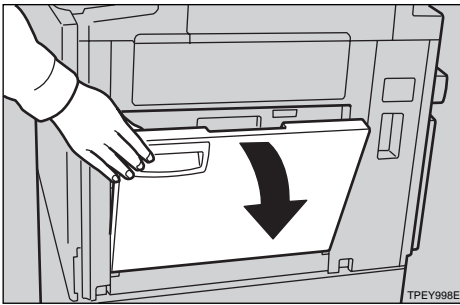

- 2 Lift the feed side/end plates.

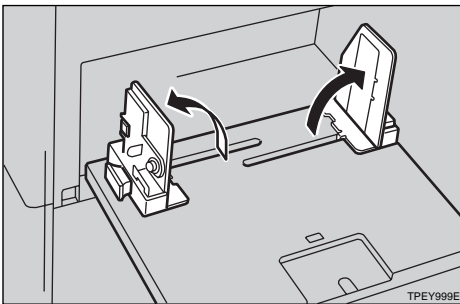

- 3 Grasp the side/end plate knob and adjust the side/end plates to match the paper size.

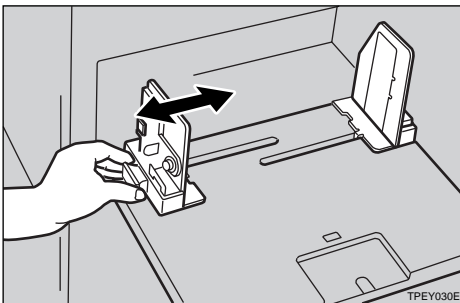

- 4 Place the paper on the paper feed tray.

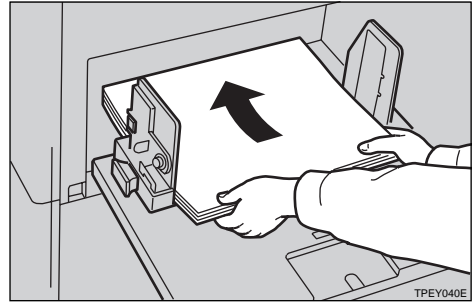

Note

- ❑ Correct the paper curl before setting the paper. If you cannot do so, stack the paper with the curl face down.

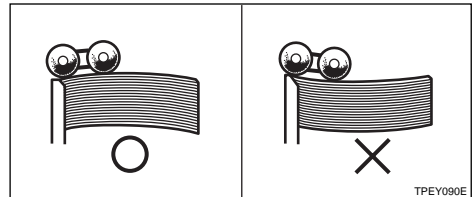

- 5 Make sure that the paper feed side/end plates make contact with the paper lightly.

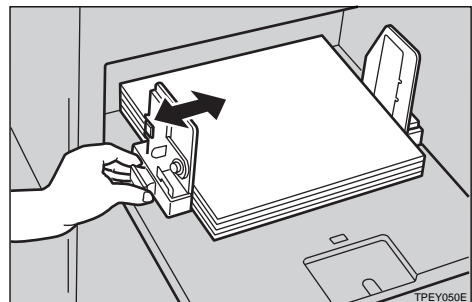

Note

- ❑ Make sure that the paper size and direction in the panel display correspond with the actual paper size and direction set on the paper feed tray.

Setting Up The Paper Delivery Tray

1

- 1 Grasp the end plate knob and move the paper delivery end plate to match the print paper size.

When you use A4, 8½" × 11" or smaller paper

- 1 Adjust the end plate to match the paper size scale on the operation panel side.

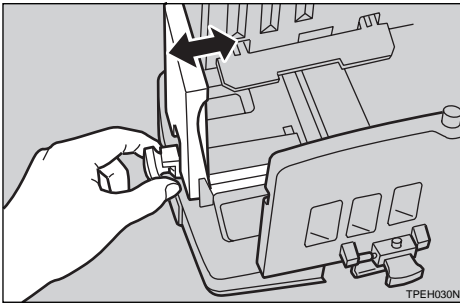

When you use B4, 8½" × 14" or larger paper

- 1 Pull out the paper delivery tray until it stops.

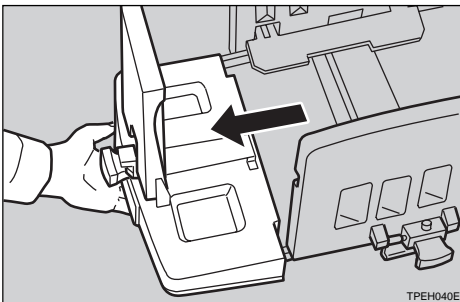

- 2 Adjust the end plate to match the paper size scale on the opposite side of the operation panel.

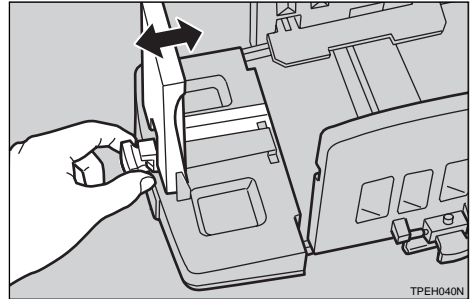

- 2 Grasp the side plate knobs and move the paper delivery side plates to match the print paper size.

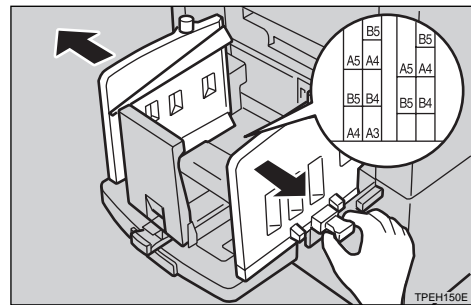

Note

- The inside of the side plates should match the paper size.

When you use thick paper (157 g/m² to 209.3 g/m², 42 lb to 55.6 lb)

- 1 Adjust the side plates to match the paper size scale on the main frame side.

When you use standard paper (47 g/m² to 128 g/m², 12.5 lb to 34 lb)

- 1 Adjust the side plates to match the paper size scale on the end plate side.

- 3** Lower or lift the paper alignment wings by turning the left and right knobs.

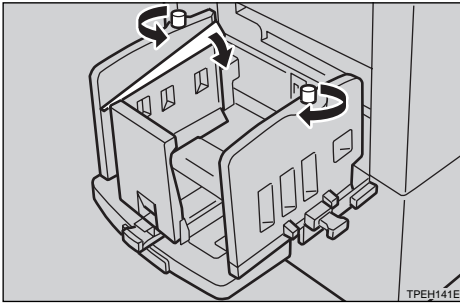

Note

- When the guides are up, you might not be able to load the unit to full capacity (1,000 sheets) depending on the paper you are using.
- Lift the paper alignment wings when B5 prints are curled.

When you use 81.4 g/m², 21.6 lb or thicker paper

- 1** Lower the paper alignment wings.

When you use 81.4 g/m², 21.6 lb or thinner and B5 or smaller paper

- 1** Lower the paper alignment wings.

When you use 81.4 g/m², 21.6 lb or thinner and A4, 8 1/2" × 11" or larger paper

- 1** Lift the paper alignment wings.

- 4** When you use A4, 8 1/2" × 11" □, or B5 □ paper, swing out the trailing edge guides.

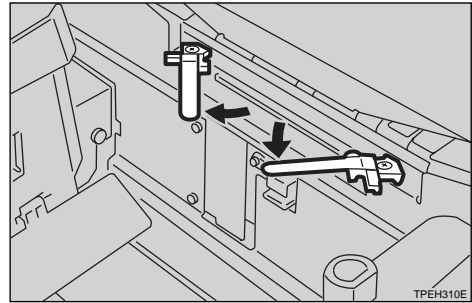

When you use A4, 8 1/2" × 11" □ paper

- 1** Swing out the guides as shown in the illustration.

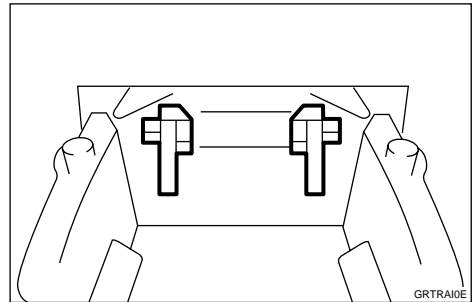

When you use B5 □ paper

- 1** Swing out the guides as shown in the illustration.

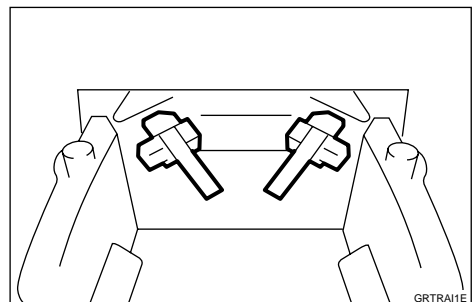

5 Turn on the main switch.

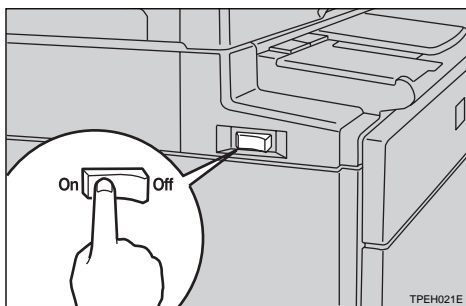

Note

- You can have the machine display how much ink and master are left when you switch it on. See “User Tools—Ink/Master Left” in ⇒ P.146 “4. Mode Setting”.

Entering a User Code to Use the Machine

If user codes are turned on, operators must input their user code before they can use the machine. The machine keeps count of the number of copies made under each user code.

Note

- ❑ If you want to use this feature, you must turn it on and register the user codes with the user tools. You can register up to 20 user codes. See “Set User Code” and “Reg. User Code” ⇒ P.154 “6. Set User Code(s)”.
- ❑ When user codes are turned on, the machine will prompt you for your user code when you turn on the main switch or after the machine has been reset.

1 Input your 4-digit user code with the Number keys.

Please input user code,
then press # key.
User Code :----

Note

- ❑ User codes are not displayed on the panel display.
- ❑ To change the number entered, press the **[Clear/Stop]** key and enter the new number.

2 Press the **[#]** key.

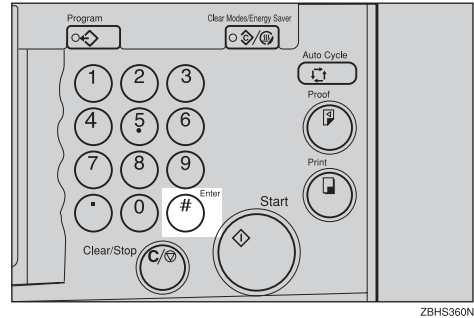

3 Make your prints.

4 To prevent others from making prints with your user code, hold down the **[Clear Modes/Energy Saver]** key, then press the **[Clear/Stop]** key.

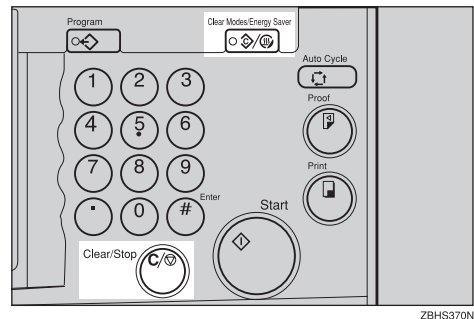

Standard Printing

1

- 1 Make sure that the machine is ready for printing.

Ready for Master Making/ Printing			
Letter	100%	A4	0.0mm
Original	Ratio	Prp.Type	Image
		Std.	0.0mm

- 2 If user codes are turned on, enter your user code with the Number keys then press the [#] key.

Reference

See ⇒ P.19 “Entering a User Code to Use the Machine”

- 3 Make sure that there are no previous settings remaining.

Note

- To clear any previous settings, press the [Clear Modes/Energy Saver] key.

- 4 Lift the platen cover.

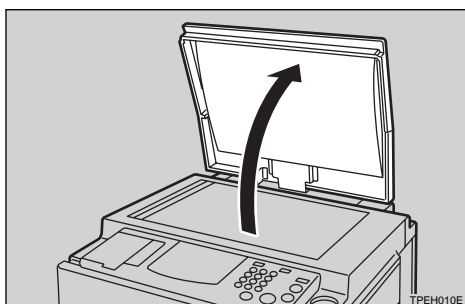

Note

- Be sure to lift the platen cover more than 30cm, 12”.

- 5 Set the original face down on the exposure glass (contact glass). The original should be aligned to the rear left corner.

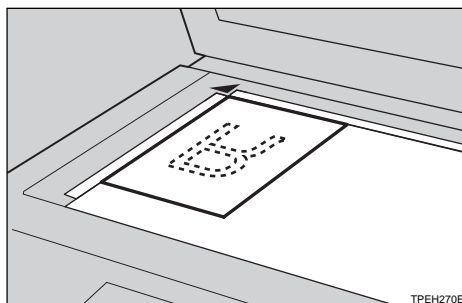

- 6 Lower the platen cover.

- 7 Set your desired settings.

- 8 Press the [Start] key.

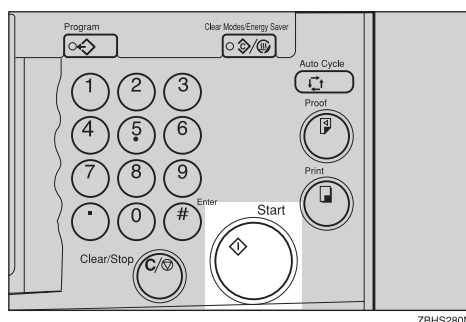

A trial print is delivered to the paper delivery tray.

- 9 Press the [Proof] key and check the image density and the image position of the proof print.

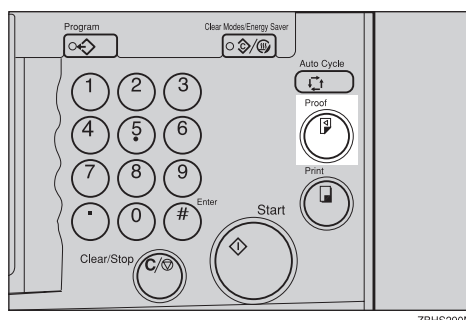

Note

- ❑ If the image position is not correct, adjust it using the **[Image ❄️]** key. See ⇒ P.24 “Adjusting the Position of Printed Images”.
- ❑ If the image density is slightly dark or light, adjust the image density using the **[◀][▶]** keys. See ⇒ P.25 “Adjusting the Image Density of Prints”.

- 10** Enter the number of prints required with the Number keys.

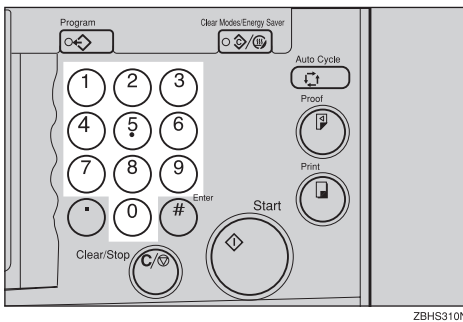

ZBHS310N

Note

- ❑ To change the number entered, press the **[Clear/Stop]** key and enter the new number.

- 11** Press the **[Print]** key.

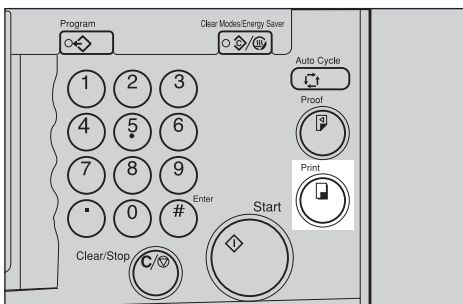

ZBHS320N

Note

- ❑ To stop the machine during a multi-print run, press the **[Clear/Stop]** key.

- ❑ To return the machine to the initial condition after printing, press the **[Clear Modes/Energy Saver]** key.

Removing Prints

- 1** Pull the front paper delivery side plate down towards you to open it.

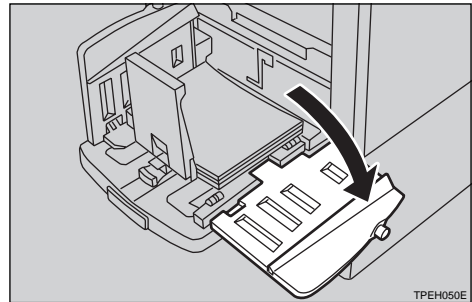

TPEH060E

Note

- ❑ You cannot open the rear paper delivery side plate.

- 2** Remove the prints from the paper delivery tray and close the paper delivery side plate.

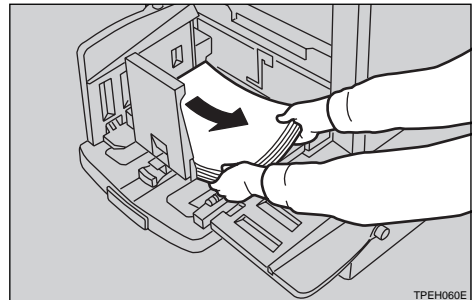

TPEH060E

When your machine is equipped with the optional sorter

1

- 1** Lift the lever and slide out the paper delivery tray.

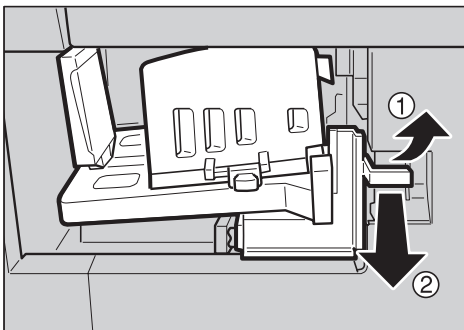

ZADP020E

- 2** Pull the front paper delivery side plate down towards you to open it, then remove the prints.

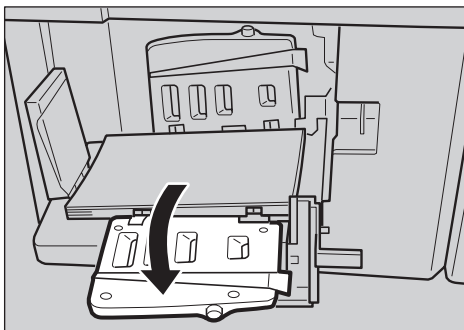

ZADP030E

- 3** Slide in the paper delivery tray.

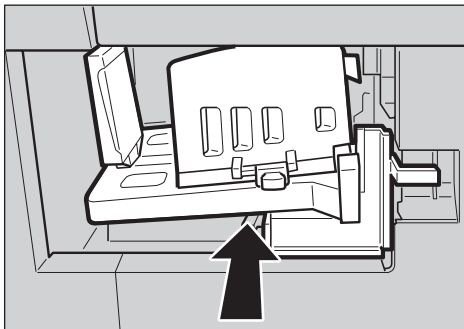

ZADP021E

Energy Saver Mode — Saving Energy

If you do not operate the machine for a certain period after printing, or when you press and hold the **【Clear Modes/Energy Saver】** key for more than three seconds, the panel display turns off and the machine enters Energy Saver mode. When you press the **【Clear Modes/Energy Saver】** key again, the machine returns to the ready condition. In Energy Saver mode, the machine uses less electricity.

See “Energy Saving” ⇒ P.141 “1. System”.

Adjusting the Position of Printed Images

1

Use the following procedure to adjust the position of print image as required.

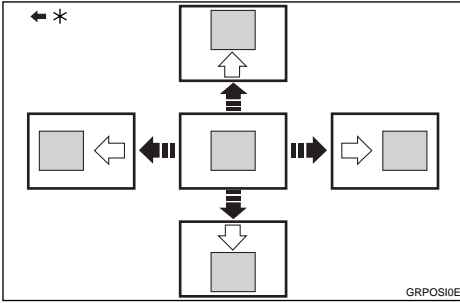

*: Paper feed direction

Note

- When the main switch is turned off, the position returns to the default.

1 Press the [Image ⚙️] key.

Ready for Master Making/ Printing			
		A4	0.0mm
Letter	100%	Std.	0.0mm
Original	Ratio	Ppr.Type	Image ⚙️



Note

- You can skip step 1 and adjust the image position directly by pressing the [◀], [▶], [▲], and [▼] keys.

2 Adjust image position using the [◀], [▶], [▲], and [▼] keys.

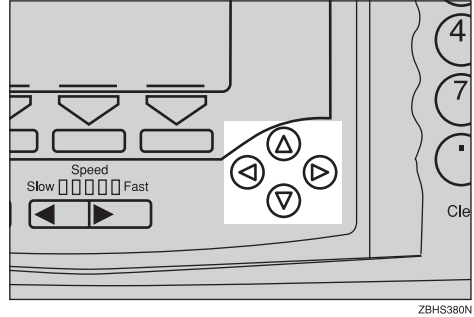

Note

- When you shift the image forwards, leave a 10mm, 0.4" margin at the leading edge. If there is no margin, paper might wrap around the drum and cause a misfeed.
- The [◀] and [▶] keys shift the image up to 15mm, 0.6" each way in 0.5mm, 0.02" steps.
- The [▲] and [▼] keys shift the image up to 10mm, 0.4" each way in 0.5mm, 0.02" steps.

3 Press the [OK] key.

4 Press the [Proof] key to check the image position.

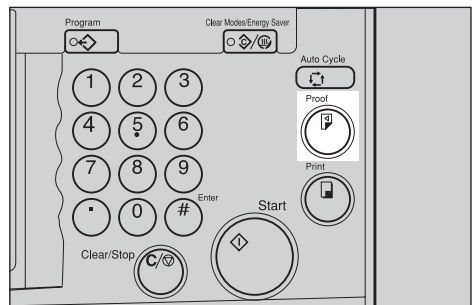

Adjusting the Image Density of Prints

There are two ways to adjust the image density of prints:

- ❖ **Before making a master**
Use the **[Image Density]** key.
- ❖ **After making a master**
Use the **[◀][▶]** (Speed) keys.

Before Making a Master

- 1** Press the **[Image Density]** key to adjust the image density.

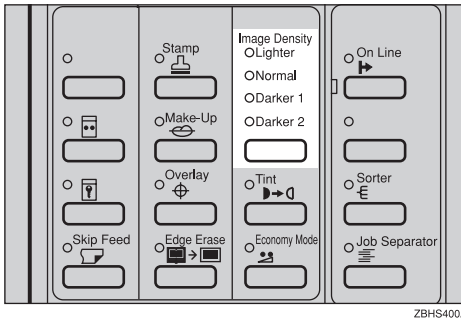

ZBHS400A

- 2** Press the **[Start]** key.

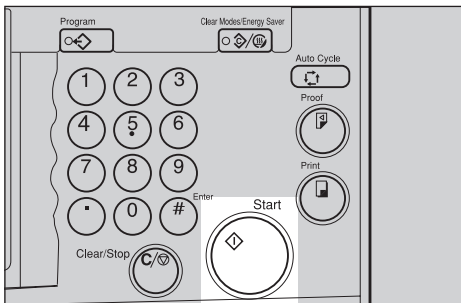

ZBHS280N

After Making a Master

- 1** To increase the image density, press the **[◀]** key. To reduce the image density, press the **[▶]** key.

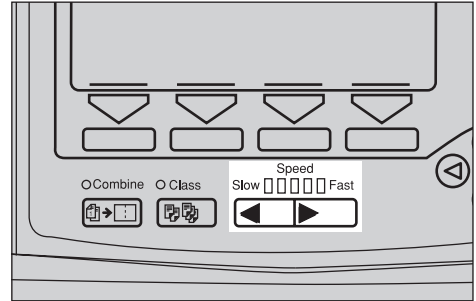

ZBHS300N

Note

- ❑ The faster the printing speed becomes, the lighter the printing density is. If you want darker prints, decrease the printing speed.

Tint Mode—Halftone Printing

1

Use this function to make halftone prints.

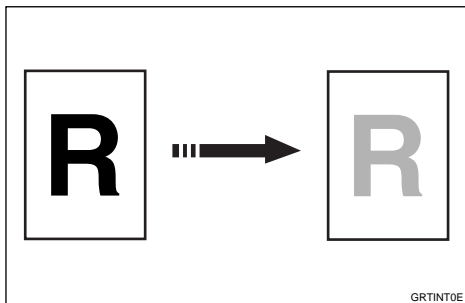

GRTINT0E

1 Press the **[Tint]** key.

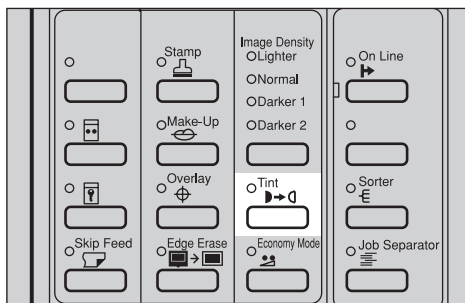

ZBHS420A

2 Press the **[Start]** key.

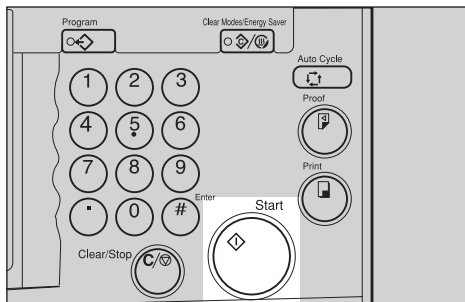

ZBHS280N

Changing the Printing Speed

Use the [◀] or [▶] key to adjust the printing speed. The relationship between printing speed and print quality depends on the type of paper you use.

- 1 Press the [▶] key to increase the speed and press the [◀] key to reduce the speed.

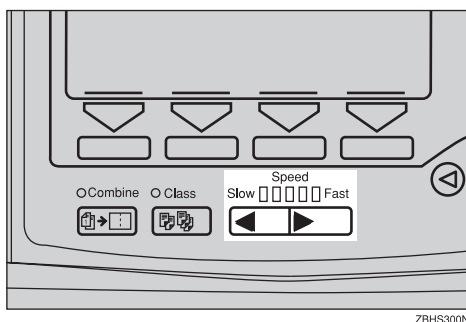

Note

- The following speeds are available:
 - Setting 1:
60 sheets/minute
 - Setting 2:
75 sheets/minute
 - Setting 3 (default):
90 sheets/minute
 - Setting 4:
105 sheets/minute
 - Setting 5:
120 sheets/minute
- The faster the printing speed becomes, the lighter the printing density is, and vice versa.
- When the machine is used in low temperature conditions, the image density might decrease. In this case, slow the printing speed down to setting 1 or 2.

Stopping a Multi-print Run

1

Stopping a Multi-print Run to Print Another Original

1 Press the **[Clear/Stop]** key.

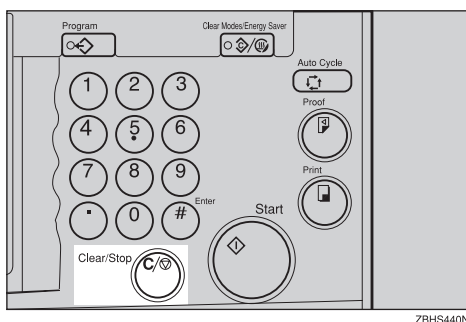

ZBHS440N

2 Set the original.

3 Enter the number of prints and press the **[Start]** key.

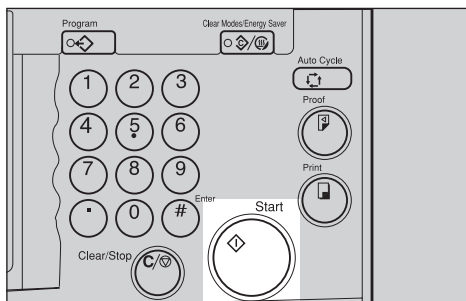

ZBHS280N

Changing the Number of Prints Entered and Checking Completed Prints

1 Press the **[Clear/Stop]** key.

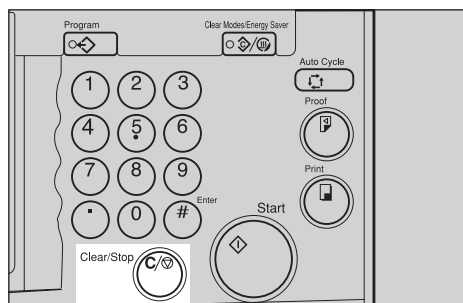

ZBHS440N

2 Change the number of prints or check the completed prints.

Note

- To change the number of prints, press the **[Clear/Stop]** key then re-enter the number of prints with the Number keys.

3 Press the **[Print]** key.

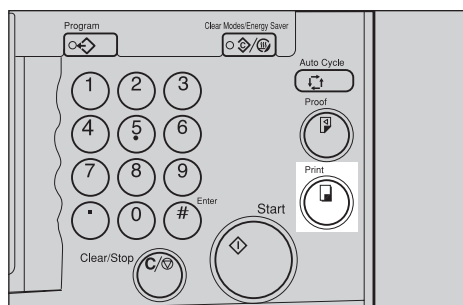

ZBHS320N

Preset Reduce/Enlarge—Reducing and Enlarging Using Preset Ratios

Use this function to have originals reduced or enlarged by a preset ratio. A total of 7 ratios are available (3 enlargement ratios, 4 reduction ratios).

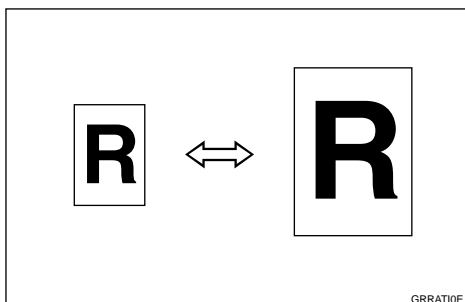

Note

- The leading edge of the print image does not shift when a print image is made with this function.

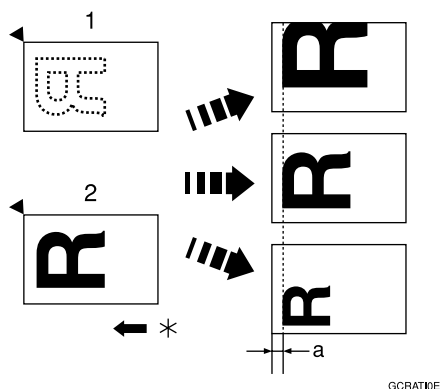

- 1: Set on the exposure glass (contact glass)
- 2: Set in the optional document feeder
- *: Paper feed direction
- a = 10mm, 0.4"

- You can select a ratio regardless of the size of an original or printing paper. With some ratios, parts of the image might not be printed or margins will appear on prints.

- You can change the preset reproduction ratios with the user tools. See "Reproduction Ratio" ⇒ P.156 "3-4 Reproduction Ratio".
- Prints can be reduced or enlarged as follows:

◆ Metric version

Ratio (%)	Original → Print paper size
141	A4 → A3, A5 → A4, B5 → B4
122	A4 → B4, A5 → B5
115	B4 → A3, B5 → A4
93	—
87	A3 → B4, A4 → B5
82	B4 → A4, B5 → A5
71	A3 → A4, A4 → A5, B4 → B5

◆ Inch version

Ratio (%)	Original → Print paper size
155	5 1/2" × 8 1/2" → 8 1/2" × 14"
129	8 1/2" × 11" → 11" × 17", 5 1/2" × 8 1/2" → 8 1/2" × 11"
121	8 1/2" × 14" → 11" × 17"
93	—
77	8 1/2" × 14" → 8 1/2" × 11"
74	11" × 15" → 8 1/2" × 11"
65	11" × 17" → 8 1/2" × 11", 8 1/2" × 11" → 5 1/2" × 8 1/2"

1 Press the [Ratio] key.

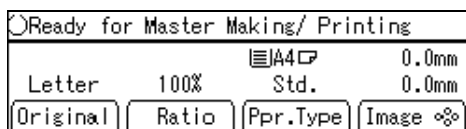

TPES570E

2 Select the desired ratio with the [←] [→] or [◀] [▶] keys.

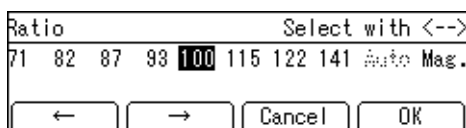

TPES530E

3 Press the [OK] key.

4 Make sure that the original and the print paper are the correct size.

5 Set your original on the exposure glass (contact glass) or in the optional document feeder.

6 Press the [Start] key.

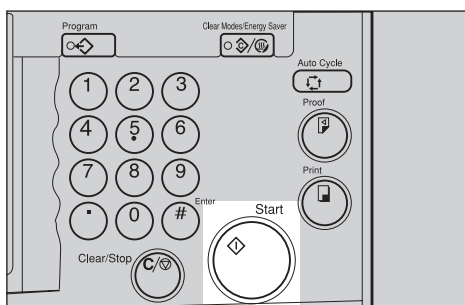

ZBHS280N

7 Check the image position of the trial or proof print.

Note

- If the image position is not correct, adjust it using the [Image] key (see ⇒ P.24 "Adjusting the Position of Printed Images").

8 Make your prints.

Auto Magnification—Having the Machine Choose Reproduction Ratios

Use this function to have the machine can choose an appropriate enlargement or reduction ratio based on the size of your original and the paper size you select.

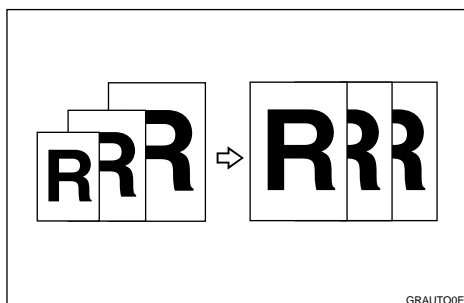

Note

- ❑ The range of ratios from which the machine can select depends on where you set the original:
 - On the exposure glass (contact glass): 50 – 200%
 - In the optional document feeder: 50 – 155%
- ❑ The table below shows the reproduction ratios that can be selected for various combinations of original and paper size.













◆ Metric version

Original Paper	A3	B4	A4	A4	B5	B5	A5 ^{*2}	A5 ^{*2}
A3	100%	115%	141%	--	163%	--	--	--
B4	87%	100%	122%	--	141%	--	--	--
A4	71%	82%	100%	100% ^{*1}	115%	115% ^{*1}	141%	141% ^{*1}
A4	71% ^{*1}	82% ^{*1}	100% ^{*1}	100%	115% ^{*1}	115%	141% ^{*1}	141%
B5	61%	71%	87%	87% ^{*1}	100%	100% ^{*1}	122%	122% ^{*1}
B5	61% ^{*1}	71% ^{*1}	87% ^{*1}	87%	100% ^{*1}	100%	122% ^{*1}	122%
A5	50%	50%	71%	71% ^{*1}	82%	82% ^{*1}	100%	100% ^{*1}
B6	--	50%	61%	61% ^{*1}	71%	71% ^{*1}	87%	87% ^{*1}

^{*1} When your machine is equipped with the optional memory board, the machine automatically rotates the original image by 90° to match the paper direction and selects an appropriate reproduction ratio. See ⇒ P.91 “Image Rotation—Rotating Original Images”.

^{*2} Set these originals in the optional document feeder.

❖ Inch version

Original Paper	11" × 17" 	8 1/2" × 14" 	8 1/2" × 11" 	8 1/2" × 11" 	8 1/2" × 5 1/2"  *2	8 1/2" × 5 1/2"  *2
11" × 17" 	100%	121%	129%	--	200%	--
8 1/2" × 14" 	77%	100%	--	--	155%	--
8 1/2" × 11" 	65%	77%	100%	100% *1	129%	129% *1
8 1/2" × 11" 	65% *1	77% *1	100% *1	100%	129% *1	129%
8 1/2" × 5 1/2"  2" 	50%	61%	65%	65% *1	100%	100% *1

*1 When your machine is equipped with the optional memory board, the machine automatically rotates the original image by 90° to match the paper direction and selects an appropriate reproduction ratio. See ⇒ P.91 "Image Rotation—Rotating Original Images".

*2 Set these originals in the optional document feeder.

Depending on the original type, a suitable reproduction ratio might not be able to be selected. See ⇒ P.13 "Originals" and ⇒ P.81 "Originals".

1 Set your original on the exposure glass (contact glass) or in the optional document feeder.

2 Press the [Ratio] key.

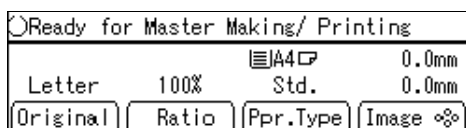

TPES520E

3 Select [Auto] with the [→] or [▷] key.

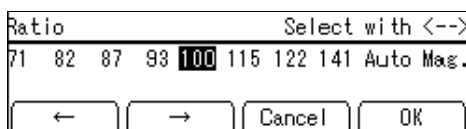

TPES570E

4 Press the [OK] key.

5 Press the [Start] key.

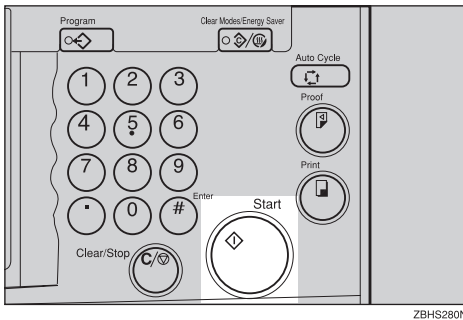

6 Check the image position of the trial or proof print.

 **Note**

- If the image position is not correct, adjust it using the [Image ] keys (See ⇒ P.24 “Adjusting the Position of Printed Images”).

7 Make your prints.

Zoom—Reducing and Enlarging in 1% Steps

1

Use this function to fine-tune the reproduction ratio in 1% steps.

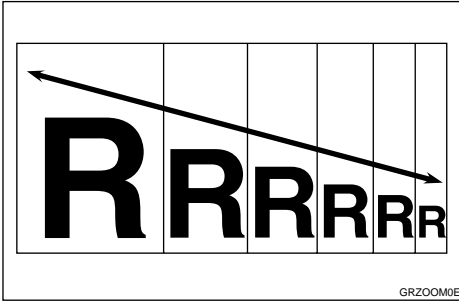

Note

- The range in which you can select a ratio depends on where you set the original:
 - On the exposure glass (contact glass): 50–200%
 - In the optional document feeder: 50–155%

1 Press the [Ratio] key.

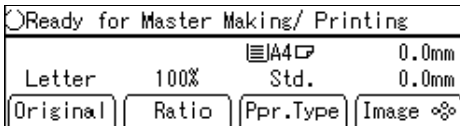

2 Select [Mag.] with the [→] or [▷] key.

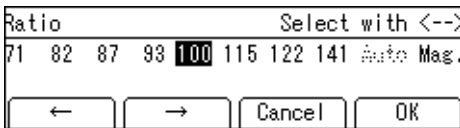

Note

- To select a custom ratio, select the closest ratio with the [←] [→] or [◀] [▶] keys. Then press the [△] or [▽] key and go to step 3.

3 Press the [OK] key.

4 Make sure that [Zoom] is selected.

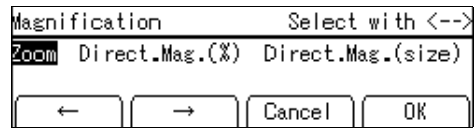

5 Press the [OK] key.

6 Select the desired reproduction ratio in one of the following ways:

Note

- To change the value entered, press the [Clear/Stop] key and enter the new value.

Using the [←] [→] or [◀] [▶] keys

1 Adjust the ratio with the [←] [→] or [◀] [▶] keys.

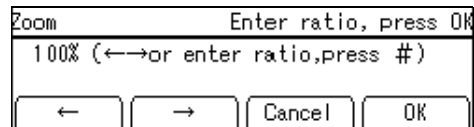

Using the Number keys

- 1 Enter the ratio with the Number keys.

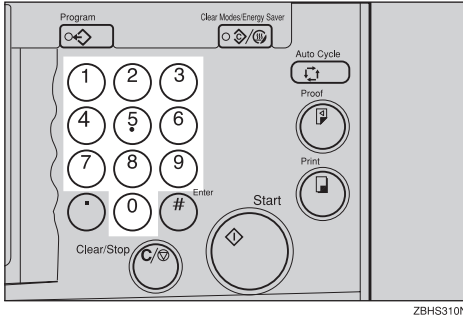

- 2 Press the [#] key.

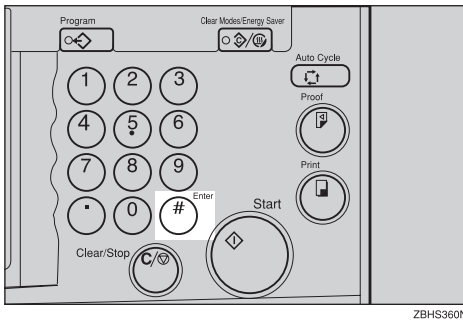

- 7 Press the [OK] key.
- 8 Make sure that the original and the print paper are the correct size.
- 9 Set your original on the exposure glass (contact glass) or in the optional document feeder.
- 10 Press the [Start] key.

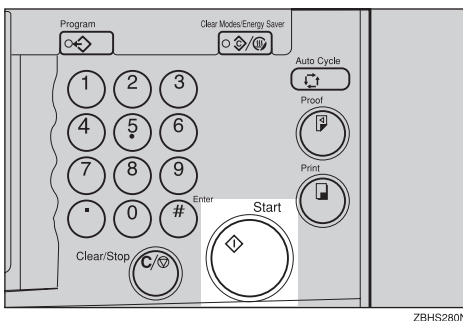

- 11 Check the image position of the trial or proof print.

Note

- If the image position is not correct, adjust it using the [Image] key (see ⇒ P.24 “Adjusting the Position of Printed Images”).

- 12 Make your prints.

Directional Magnification (%)—Stretching and Squeezing the Image in 1% Steps

1

Use this function to choose different reproduction ratios for the horizontal and vertical directions. The result is a squeezing or stretching effect.

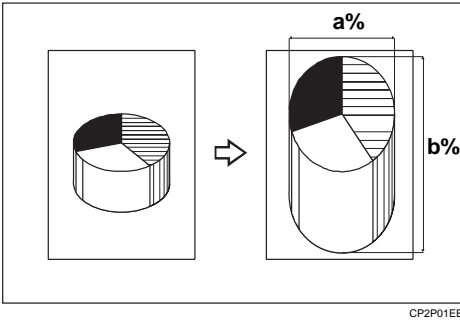

CP2P01EE

Note

- The range in which you can select ratios depends on where you set the original:
 - On the exposure glass (contact glass): 50 – 200%
 - In the optional document feeder: 50 – 155%

1 Press the [Ratio] key.

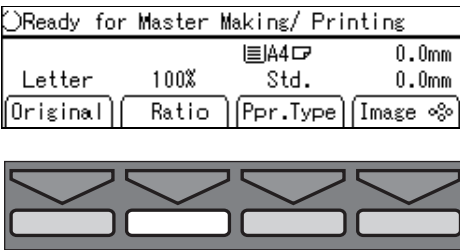

TPES570E

2 Select [Mag.] with the [→] or [▷] key.

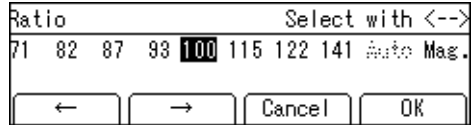

TPES570E

3 Press the [OK] key.

4 Select [Direct.Mag.(%)] with the [→] or [▷] key.

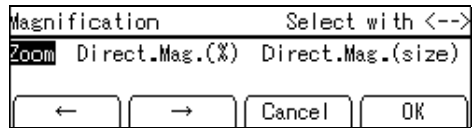

TPES570E

5 Press the [OK] key.

6 Enter the vertical and horizontal ratio.

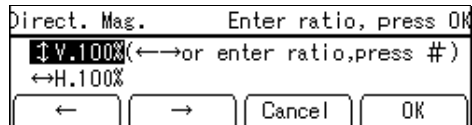

Note

- To change the value entered, press the [Clear/Stop] key and enter the new value.

Adjusting ratios with the [←] [→] or [◀] [▶] keys

- 1 Adjust the vertical ratio with the [←] [→] or [◀] [▶] keys.
- 2 Press the [▽] key.
- 3 Adjust the horizontal ratio with the [←] [→] or [◀] [▶] keys.

Entering ratios with the Number keys

- 1 Enter the vertical ratio with the Number keys.
 - 2 Press the [#] key.
 - 3 Enter the horizontal ratio with the Number keys.
 - 4 Press the [#] key.
- 7 Press the [OK] key.
- 8 Make sure that the original and the print paper are the correct size.
- 9 Set your original on the exposure glass (contact glass) or in the optional document feeder.
- 10 Press the [Start] key.

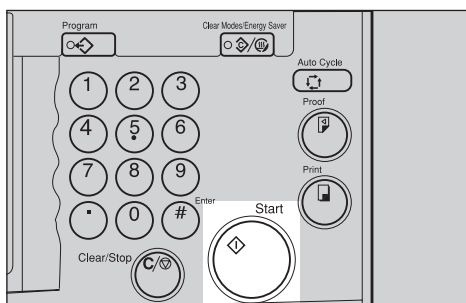

ZBHS280N

- 11 Check the image position of the trial or proof print.

Note

- If the image position is not correct, adjust it using the [Image ⌘] key (see ⇒ P.24 "Adjusting the Position of Printed Images").

- 12 Make your prints.

1

Directional Magnification (Size)— Stretching and Squeezing the Image into the Copy Area

Use this function to have the machine select suitable reproduction ratios based upon the dimensions of the print you require, and the size of the original you specify.

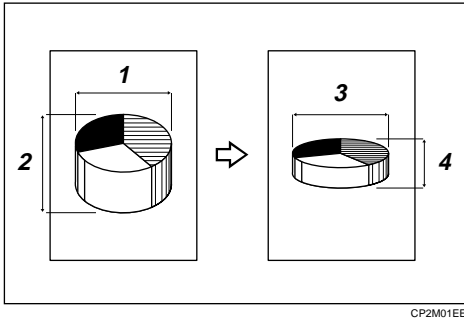

- 1: Horizontal original size
- 2: Vertical original size
- 3: Horizontal print size
- 4: Vertical print size

Note

You can enter the sizes within the following ranges:

Metric version	1 - 999mm (in 1mm steps)
Inch version	0.1" - 99.9" (in 0.1" steps)

- The range of ratios from which the machine can select depends on where you set the original:
 - On the exposure glass (contact glass): 50-200%
 - In the optional document feeder: 50-155%
- If the calculated ratio is over the maximum or under the minimum ratio, it is corrected within the range of the ratio automatically.

1 Press the [Ratio] key.

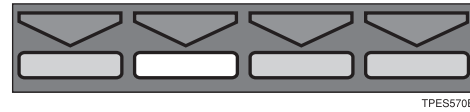

2 Select [Mag.] with the [→] or [▷] key.

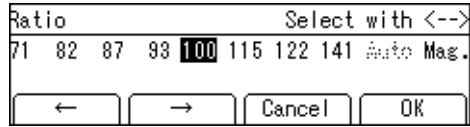

3 Press the [OK] key.

4 Select [Direct.Mag.(Size)] with the [→] or [▷] key.

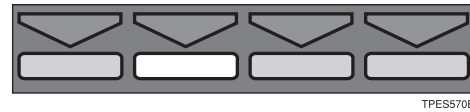
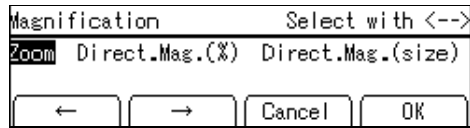

5 Press the [OK] key.

- 6** Enter the vertical original size with the Number keys and press the **[#]** key.

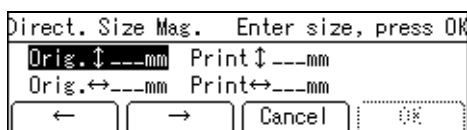

Note

- To change the value entered, press the **[Clear/Stop]** key and enter the new value.
- Up to 999mm, 99.9" can be entered.

- 7** Enter the vertical print size with the Number keys and press the **[#]** key.

- 8** Enter the horizontal original size with the Number keys and press the **[#]** key.

- 9** Enter the horizontal print size with the Number keys.

- 10** Press the **[OK]** key.

The machine will select appropriate reproduction ratios for the vertical and horizontal directions.

- 11** Make sure that the original and the print paper are the correct size.

- 12** Set your original on the exposure glass (contact glass) or in the optional document feeder.

- 13** Press the **[Start]** key.

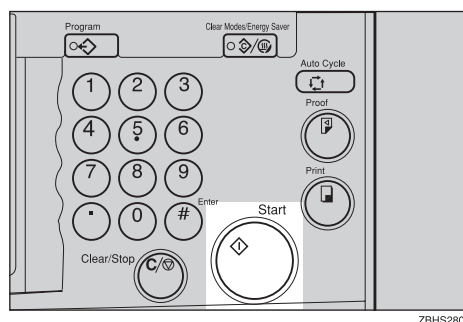

- 14** Check the image position of the trial or proof print.

Note

- If the image position is not correct, adjust it using the **[Image ⌘]** key (see ⇒ P.24 "Adjusting the Position of Printed Images").

- 15** Make your prints.

Erasing centre and Edge Margins

1

When printing from thick books, or similar originals, the binding margin at the centre and the edges might appear on prints. To prevent this, perform the following steps.

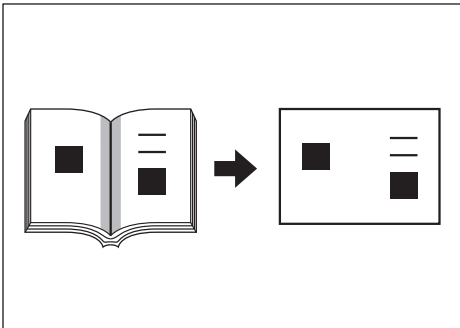

Important

- Be sure to keep the platen cover at an angle of at least 25 degrees with the exposure glass.
- If you do not press hard on the book while it is scanned, the margin at the centre might not be erased completely.

Note

- If your originals have solid images at the edges, the machine might recognize the solid images as shadows and not copy them. In this case, use Edge Erase mode so that only the shadows are not copied. See ⇒ P.41 "Edge Erase—Erasing Edge Margins"

1 Set the book on the exposure glass.

2 Keep the platen cover at an angle of at least 25 degrees with the exposure glass.

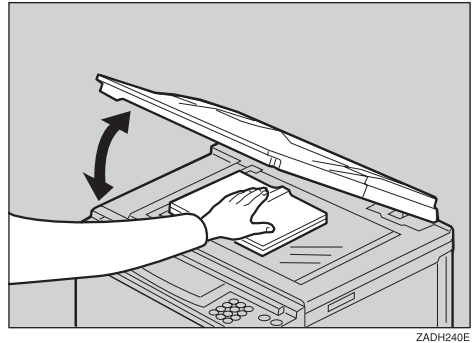

3 Press the [Start] key.

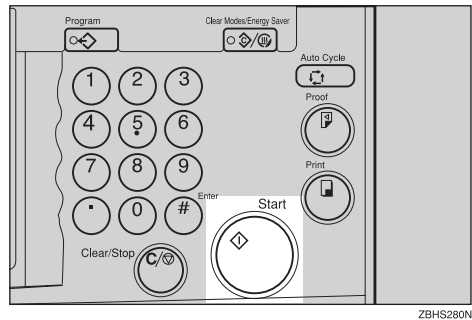

Note

- Press hard on the book with your hand while it is scanned.

4 Check the image position of the trial or proof print.

Note

- If the image position is not correct, adjust it using the [Image] key (see ⇒ P.24 "Adjusting the Position of Printed Images").

5 Make your prints.

Edge Erase—Erasing Edge Margins

This function erases all four sides of the original image.

❖ Using Edge Erase mode

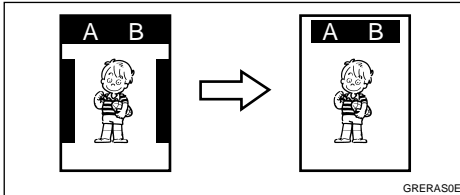

❖ When not using Edge Erase mode

When printing from thick books, or similar originals, the binding margin at the center and the edges might appear on prints. The machine erases these margins automatically. If you do not use Edge Erase mode using the following kind of originals, the images to be printed might be also erased.

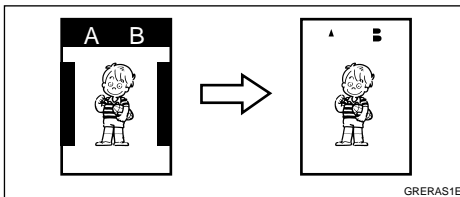

Note

- ❑ You can adjust the size of the margins with the user tools. The default is 2mm, 0.1". See ⇒ P.158 "3-9 Margin Erase Area".

1 Press the [Edge Erase] key.

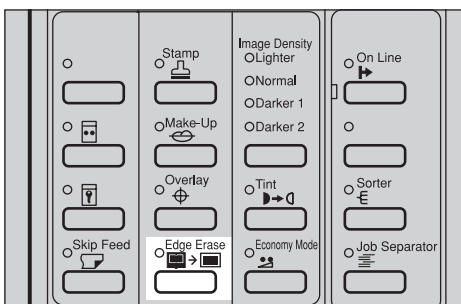

2 Select the size and direction of the original with the [←] [→] or [◀] [▶] keys.

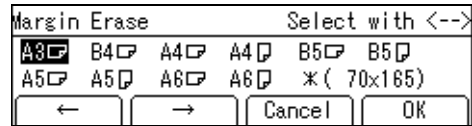

3 Press the [OK] key.

4 Set your original on the exposure glass (contact glass) or in the optional document feeder.

5 Press the [Start] key.

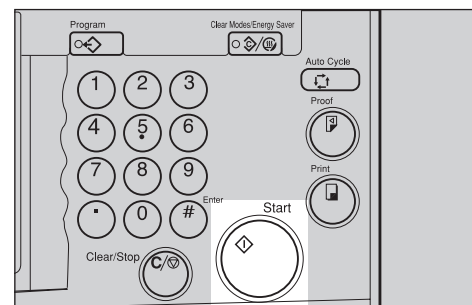

6 Check the image position of the trial or proof print.

Note

- ❑ If the image position is not correct, adjust it using the [Image] key (see ⇒ P.24 "Adjusting the Position of Printed Images").

7 Make your prints.

Printing onto Various Kinds of Paper

1

Before printing onto thick paper, thin paper, envelopes or special kinds of paper loaded in the Paper feed tray, you must select the paper type.

Printing onto Thick Paper

If you wish to print onto thick (157 to 209.3g/m², 42 to 55.6 lb or heavier) paper, perform the following steps.

1 Press the [Ppr.Type] key.



TPES520E

2 Select [Thick] with the [→] or [▷] key.

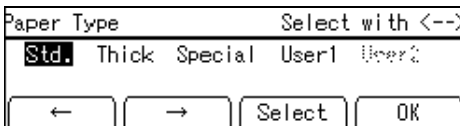

TPES570E

3 Press the [OK] key.

Printing onto Thin Paper

If you wish to print onto thin (47.1g/m², 12.5 lb or lighter) paper, perform the following steps.

1 Press the [Ppr.Type] key.



TPES520E

2 Make sure that [Std.] is selected.

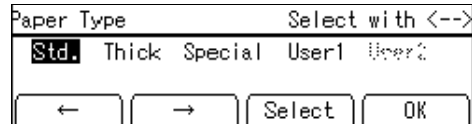

3 Press the [OK] key.

Printing onto Envelopes

1 Press the [Ppr.Type] key.

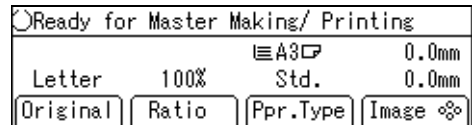

TPES520E

2 Select [Special] with the [→] or [▷] key.

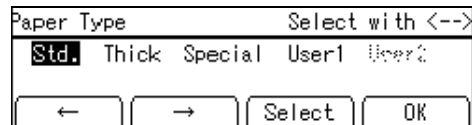

TPES530E

3 Press the [OK] key.

- Place the envelopes in the Paper feed tray as shown in the illustration.

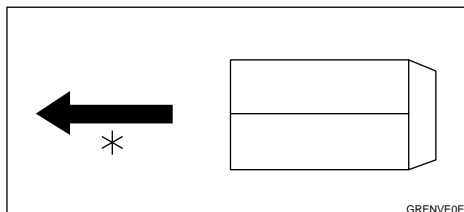

*: Paper feed direction

Note

- When you use envelopes, the Paper feed tray capacity is about 150 sheets (85g/m², 22 lb) or enough to load a stack up to 105mm, 4.1" high.

- If your envelopes do not feed in well, lift the paper feed tray a little then lower it so that it slants up slightly.

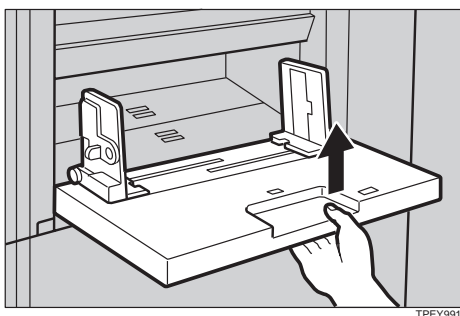

Printing onto Special Kinds of Paper

Preparation

To use this function, you have to register the special paper type in **[User1]** or **[User2]** with the user tools. See ⇒ P.161 "4-19 Type of Paper".

- Press the **[Ppr.Type]** key.

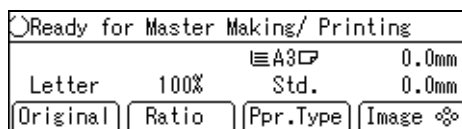

- Select **[User1]** or **[User2]** with the **[←]** **[→]** or **[<]** **[>]** keys.

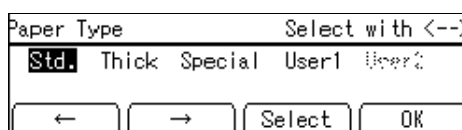

- Press the **[OK]** key.

To prevent paper misfeeds:

If paper misfeeds occur frequently even if you select a suitable paper type, follow the steps below.

- Press the **[Select]** key.

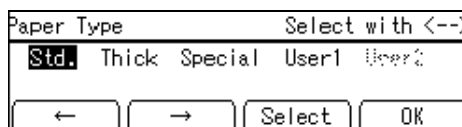

- Select the type of paper misfeed and frequency with the **[<]**, **[>]**, **[△]**, or **[▽]** key.

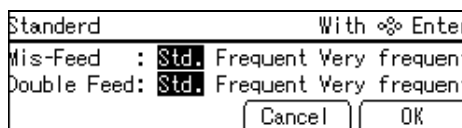

- ③ Press the **[OK]** key.

If paper misfeeds occur frequently in the paper exit section even if you use standard or thin paper and select the **[Std.]**, do the following:

- ① Set the wing guide to the “Down” position with the user tools. See “Deflector Angle” ⇒ P.146 “4. Mode Setting”.

If A4 – B5, 8¹/₂" × 11" thick paper is not delivered properly to the paper delivery tray, do the following:

- ① Set the wing guide to the “Up” position with the user tools. See “Deflector Angle” ⇒ P.146 “4. Mode Setting”.



Selecting a Mode to Match Your Original

Select one of the following four modes to match your originals:

- ❖ **Letter mode**
Select when originals contain only letters (no pictures).
- ❖ **Letter/Photo mode**
Select when originals contain photographs or pictures with letters.
- ❖ **Photo mode**
Select when originals contain photographs or pictures with delicate tones.
- ❖ **Pencil mode**
Select when originals are written in pencil.

Note

- ❑ You can adjust the sharpness of text in Letter mode with the user tools (see “Adjusting sharpness of letters” ⇒ P.146 “4. Mode Setting”).
- ❑ When using Photo mode to print originals with both text and photographs, the text will appear lighter. To avoid this, select Letter/Photo mode. Alternatively, use the optional Make-up function to specify Lettermode for text areas and Photo mode for photograph areas.

Letter/Photo Mode Printing

- 1** Press the [Original] key.

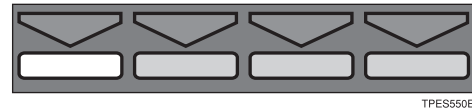
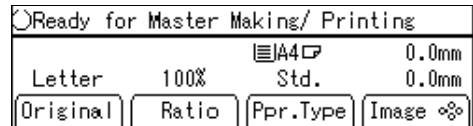

TPES590E

- 2** Select [Letter/Photo] with the [→] or [▷] key.

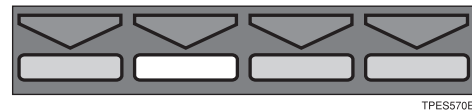
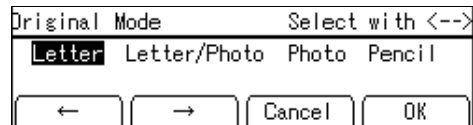

TPES570E

- 3** Press the [OK] key.

- 4** Adjust the lightness with the [←] [→] or [◀] [▶] keys.

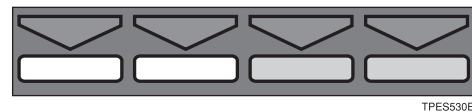
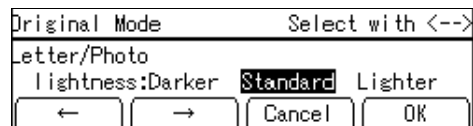

TPES30E

- 5** Press the [OK] key.

- 6** Set your original on the exposure glass (contact glass) or in the optional document feeder.

1

7 Press the **[Start]** key.

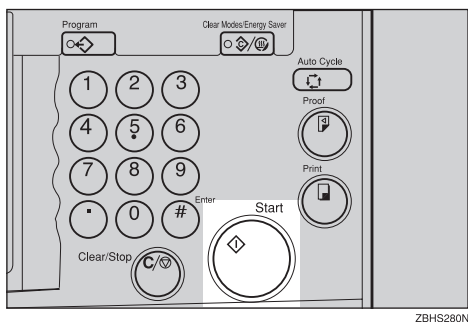

8 Check the image position of the trial or proof print.

Note

- If the image position is not correct, adjust it using the **[Image ⌘]** key (see ⇒ P.24 “Adjusting the Position of Printed Images”).

9 Make your prints.

Photo Mode Printing

1 Press the **[Original]** key.

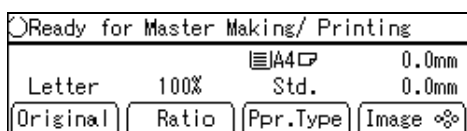

TPES550E

2 Select **[Photo]** with the **[→]** or **[▷]** key.

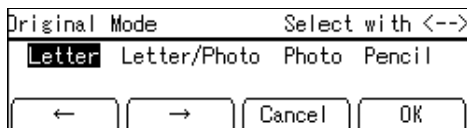

TPES570E

3 Press the **[OK]** key.

4 Select the screen Saver coarseness with the **[←]** **[→]** or **[◀]** **[▶]** keys.

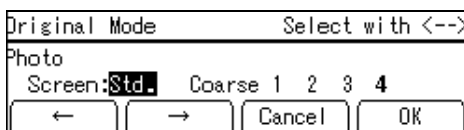

TPES30E

Note

- Four coarseness settings are available:
 - Setting 4: coarsest
 - Setting 3: coarser than setting 2
 - Setting 2: coarser than setting 1
 - Setting 1: coarser than the standard setting

5 Press the **[OK]** key.

6 Adjust the lightness with the **[←]** **[→]** or **[◀]** **[▶]** keys.

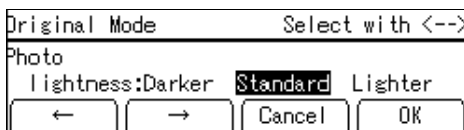

TPES30E

7 Press the **[OK]** key.

8 Set your original on the exposure glass (contact glass) or in the optional document feeder.

9 Press the **[Start]** key.

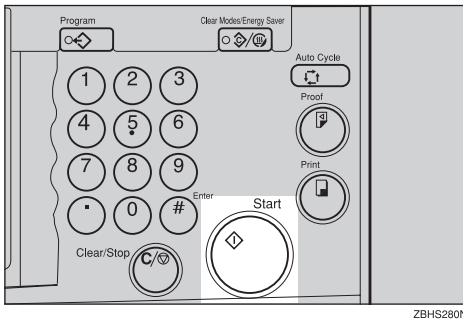

2 Select **[Pencil]** with the **[←]** or **[<]** key.

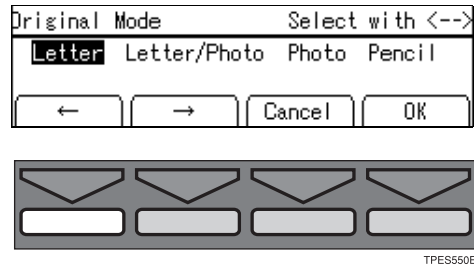

10 Check the image position of the trial or proof print.

Note

- ❑ If the image position is not correct, adjust it using the **[Image ⚙️]** key (see ⇒ P.24 "Adjusting the Position of Printed Images").

11 Make your prints.

Pencil Mode Printing

Note

- ❑ Originals written in pencil should be set on the exposure glass (contact glass).

1 Press the **[Original]** key.

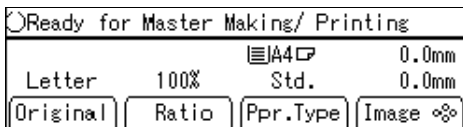

3 Press the **[OK]** key.

4 Set your original on the exposure glass (contact glass).

5 Press the **[Start]** key.

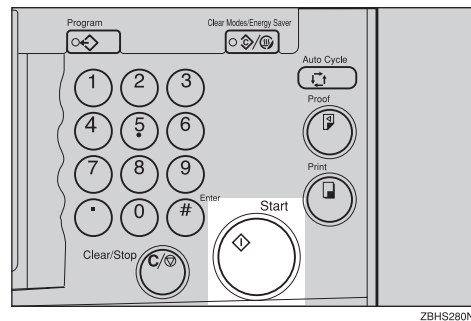

6 Check the image position of the trial or proof print.

Note

- ❑ If the image position is not correct, adjust it using the **[Image ⚙️]** key (see ⇒ P.24 "Adjusting the Position of Printed Images").

7 Make your prints.

Economy Mode—Saving Ink

1

When you want to save ink, select Economy mode.

Note

Prints will be lighter in this mode.

1 Press the **[Economy Mode]** key.

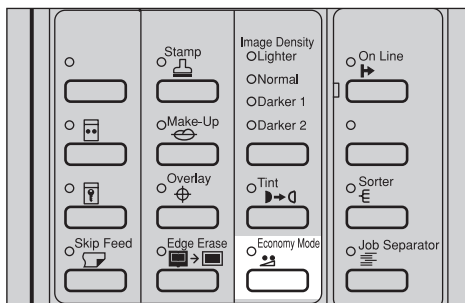

ZBHS480A

2 Set your original on the exposure glass (contact glass) or in the optional document feeder.

3 Press the **[Start]** key.

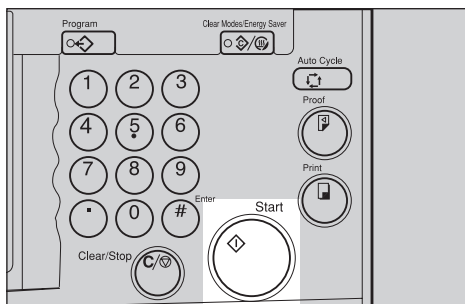

ZBHS280N

4 Check the image position of the trial or proof print.

Note

If the image position is not correct, adjust it using the **[Image ⦿]** key (see ⇒ P.24 “Adjusting the Position of Printed Images”).

5 Make your prints.

Auto Cycle—Making Master and Prints in one Operation

Use the **[Auto Cycle]** key to process masters and make prints in a single operation.

Note

- When you use the optional document feeder, it is not necessary to place originals one by one. All originals are fed and prints are completed after you press the **[Start]** key.

- 1** Set your original on the exposure glass (contact glass) or in the optional document feeder.

Note

- You can set up to 30 originals into the optional document feeder.

- 2** Enter the number of prints required with the Number keys.

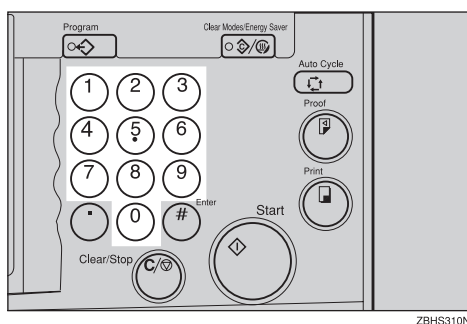

ZBHS310N

- 3** Press the **[Start]** key.

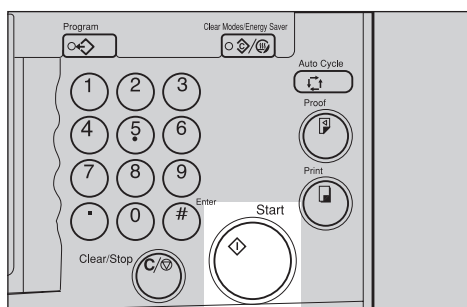

ZBHS280N

- 4** Check the image position of the trial or proof print.

Note

- If the image position is not correct, adjust it using the **[Image ❄️]** key (see ⇒ P.24 “Adjusting the Position of Printed Images”).

- 5** Press the **[Auto Cycle]** key.

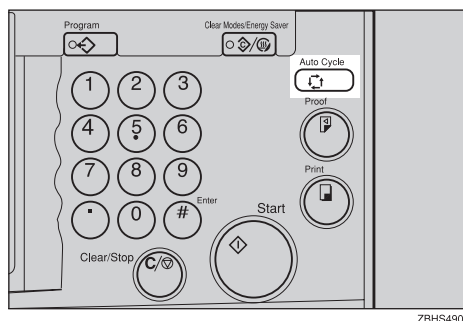

ZBHS490N

- 6** Press the **[Print]** key.

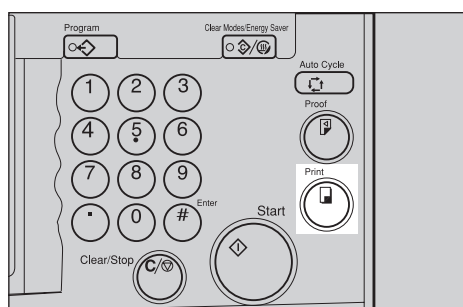

ZBHS320N

Note

- Repeat steps **1** through **3** until all originals are printed when you are setting originals on the exposure glass (contact glass).
- If you set the original in the optional document feeder, originals are fed and prints are completed automatically.

All Class Mode—Making Variable Numbers of Prints from the Same Original Using All Stored Data

Preparation

You have to store the number of students in each class with the user tools. See ⇒ P.157 “3-5 Class Enter No.”

Use the **[Class]** key to make sets of prints from the same original. All the stored numbers of prints are made for each set.

This feature is useful for teachers who frequently make multiple print sets for all the classes e.g. notes, handouts, test etc.

Using a standard print function, the teacher would have to stand by the machine entering the number of prints and pressing the **[Print]** key for each class. However, All Class mode allows you to store the number of students in each class into the machine memory beforehand with the user tools. Whenever you need to make print sets for all the classes, set your original, select **[ALL]** and press the **[Start]** key. Print sets will be made containing the correct number of prints for each class.

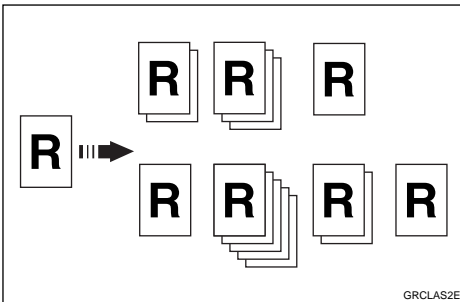

Note

- ❑ When you choose All Class mode, Job Separation mode is automatically turned on. The job separator pulls the top sheet of the each set delivered to the paper delivery tray to mark the end of each printed set. The next cycle begins automatically. See ⇒ P.76 “Job Separation—Separating Printing Sets in the Paper Delivery Tray”
- ❑ You can cancel Job Separation mode in All Class mode with the user tools (see “Auto Separate” ⇒ P.146 “4. Mode Setting”).

1 Press the **[Class]** key.

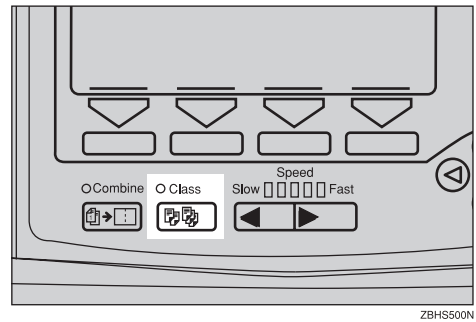

2 Make sure that the **[ALL]** is selected.

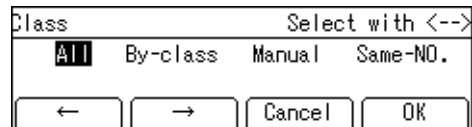

3 Press the **[OK]** key.

4 Set one original on the exposure glass (contact glass) or in the optional document feeder.

5 Press the **[Start]** key.

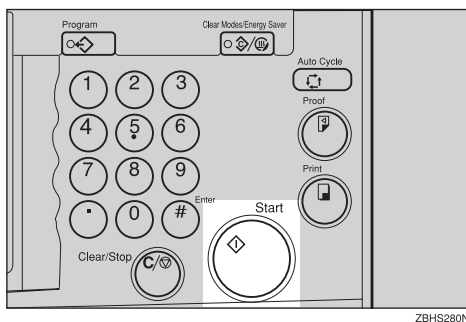

6 Check the image position of the trial or proof print.

 **Note**

- If the image position is not correct, adjust it using the **[Image ⌘]** key (see ⇒ P.24 “Adjusting the Position of Printed Images”).

7 Make your prints.

Auto Class Mode— Making Variable Numbers of Prints from the Same Original Using Stored Data

Preparation

You have to store the number of students in each class with the user tools. See ⇒ P.157 “3-5 Class Enter No.”.

Use the **[Class]** key to make sets of prints from the same original. The stored numbers of prints are made for each set.

This feature is useful for teachers who frequently make multiple print sets for their classes, ex. notes, handouts, tests etc.

Using a standard print function, the teacher would have to stand by the machine entering the number of prints and pressing the **[Print]** key for each class. However, Auto Class mode allows you to store the number of students in each class into the machine memory beforehand with the user tools. Then, whenever you need to make print sets for several classes, set your original, select the classes who need prints and press the **[Start]** key. Print sets will be made containing the correct number of prints for each class.

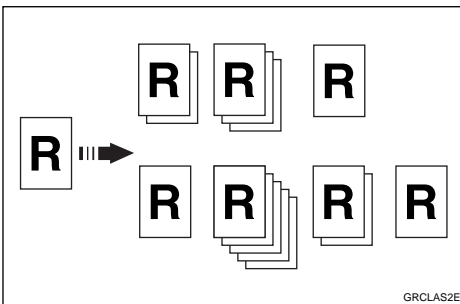

Note

- When you set Auto Class mode, Job Separation mode is automatically turned on. The job separator pulls the top sheet of the each set delivered to the paper delivery tray to mark the end of each printed set. The next cycle begins automatically. See ⇒ P.76 “Job Separation—Separating Printing Sets in the Paper Delivery Tray”.
- You can cancel Job Separation mode in Auto Class mode with the user tools (see “Auto Separate” ⇒ P.146 “4. Mode Setting”).

1 Press the **[Class]** key.

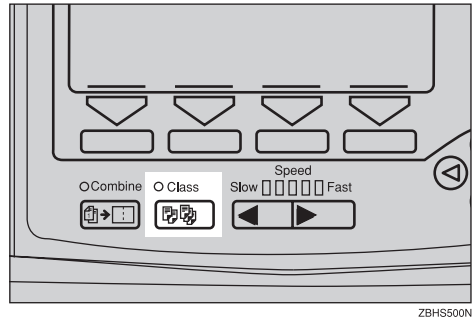

2 Select **[By-class]** with the **[→]** or **[▷]** key.

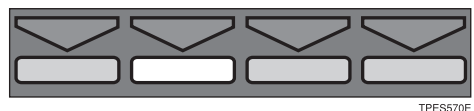
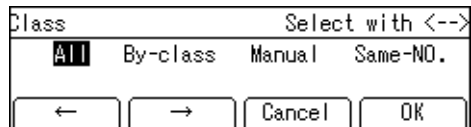

3 Press the **[OK]** key.

4 Select the desired classes for each grade.

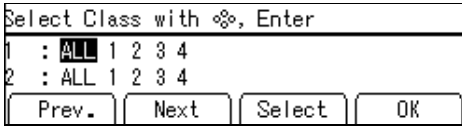

Selecting classes with the [◀], [▶], [△], or [▽] key

1 Select the desired class for the 1st grade with the [▶] key.

The number of students is displayed on the counter.

Note

- When you want to select all the classes, select [ALL].

2 Press the [Select] key.

Note

- Repeat steps **1** and **2** until you have finished designating classes for the 1st grade.
- To cancel selection of a class, select that class with the [◀], [▶], [△], or [▽] key then press the [Cancel] key.
- When you want to select many classes for one grade, first select [ALL] and press the [Select] key then deselect the unnecessary classes with the [Cancel] key.

3 Press the [▽] key.

Now you can select classes for the 2nd grade.

4 Select the desired class for the 2nd grade with the [◀], [▶], [△], or [▽] key.

5 Press the [Select] key.

Note

- Repeat steps **3** to **5** until you have finished designating all the desired classes.

Selecting classes with the Number keys

1 Enter the desired grade and class with the Number keys.

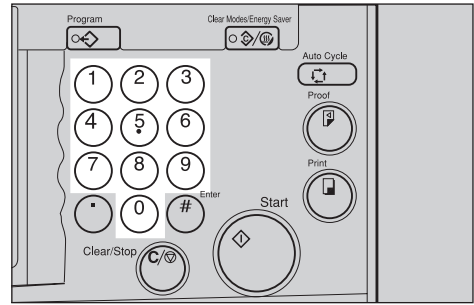

ZBHS310N

Note

- For example, to select grade 2 class 4, enter 24.
- When you want to select all the classes for one grade, enter the grade number followed by 0.

2 Press the [#] key.

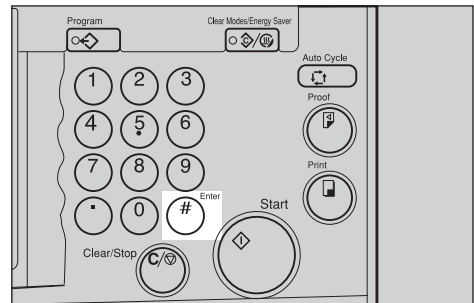

ZBHS360N

Note

- To cancel a class, select that class with the [◀], [▶], [△], or [▽] key then press the [Cancel] key.

- Repeat steps ❶ and ❷ until you have finished selecting all the desired classes.

1

5 Press the [OK] key.

6 Set one original on the exposure glass (contact glass) or in the optional document feeder.

7 Press the [Start] key.

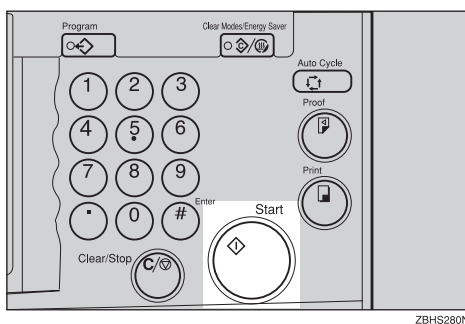

8 Check the image position of the trial or proof print.

Note

- If the image position is not correct, adjust it using the [Image ⌘] key (see ⇒ P.24 “Adjusting the Position of Printed Images”).

9 Make your prints.

Manual Class Mode with one Original— Making Variable Numbers of Prints from the Same Original

Use the **[Class]** key to make sets of prints from the same original. Various numbers of prints are made for each set.

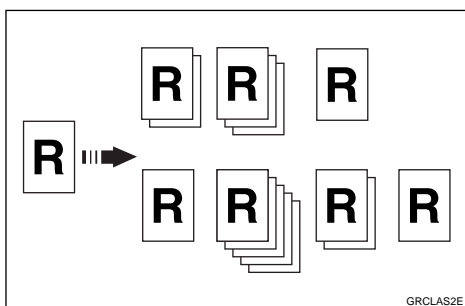

Note

- ❑ When you set Manual Class mode, Job Separation mode is automatically turned on. The job separator pulls the top sheet of the each set delivered to the paper delivery tray to mark the end of each printed set. The next cycle begins automatically. See ⇒ P.76 “Job Separation—Separating Printing Sets in the Paper Delivery Tray”.
- ❑ You can cancel Job Separation mode in Manual Class mode with the user tools (see “Auto Separate” ⇒ P.146 “4. Mode Setting”).

1 Press the **[Class]** key.

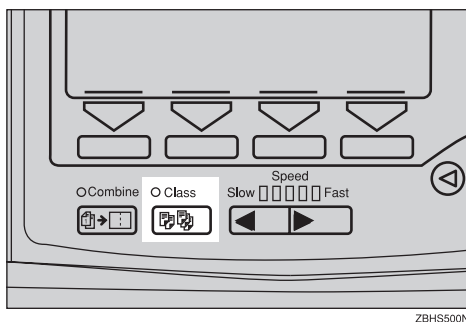

2 Select **[Manual]** with the **[→]** or **[▷]** key.

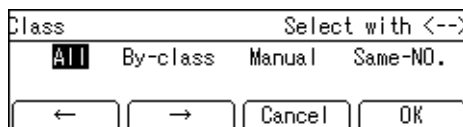

3 Press the **[OK]** key.

4 Enter the desired number of prints for the first set with the **Number** keys.

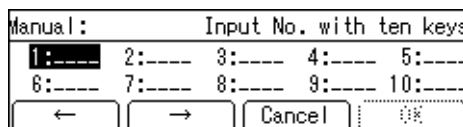

5 Press the **[#]** key.

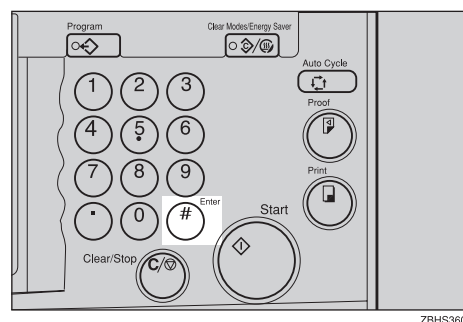

1

6 Enter the desired number of prints for the second set with the Number keys.

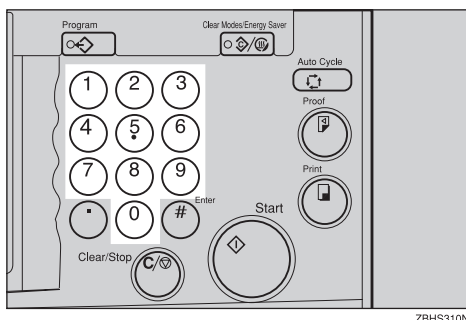

12 Make your prints.

7 Press the [#] key.

Note

- Repeat steps **6** and **7** for each set.
- The maximum number of sets that can be made is 20.

8 Press the [OK] key.

9 Set one original on the exposure glass (contact glass) or in the optional document feeder.

10 Press the [Start] key.

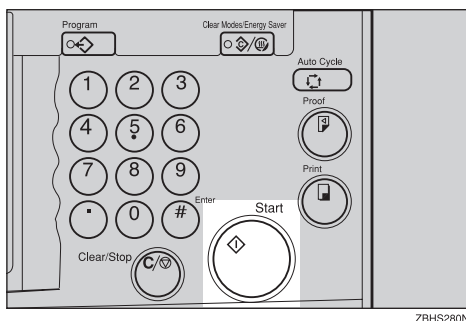

11 Check the image position of the trial or proof print.

Note

- If the image position is not correct, adjust it using the [Image ⌘] key (see ⇒ P.24 "Adjusting the Position of Printed Images").

Manual Class Mode with 2 or More Originals—Making Variable Numbers of Prints from Different Originals

1

Preparation

To use this function, you have to select “by each original” with the “Class Manual Set” setting in the user tools. See “Class Manual Set” ⇒ P.146 “4. Mode Setting”.

Use the **[Class]** key to make sets of prints from different originals. Various numbers of prints are made for each set.

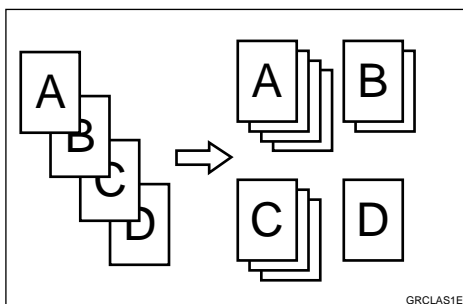

Note

- ❑ When you set Manual Class mode, Job Separation mode is automatically turned on. The job separator pulls the top sheet of the each set delivered to the paper delivery tray to mark the end of each printed set. The next cycle begins automatically. See ⇒ P.76 “Job Separation—Separating Printing Sets in the Paper Delivery Tray”.
- ❑ You can cancel Job Separation mode in Manual Class mode with the user tools (see “Auto Separate” ⇒ P.146 “4. Mode Setting”).
- ❑ With the optional document feeder, you can set several originals and make prints of all of them at once. See ⇒ P.84 “Manual Class Mode with Two or More Originals Using the Document Feeder”.

1 Press the **[Class]** key.

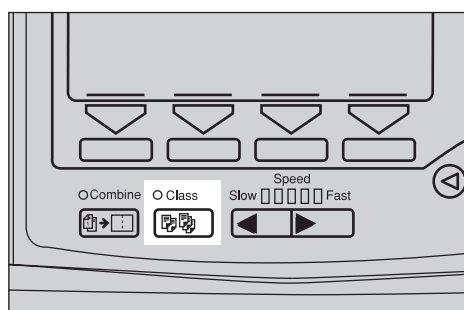

ZBHS500N

2 Select **[Manual]** with the **[→]** or **[▷]** key.

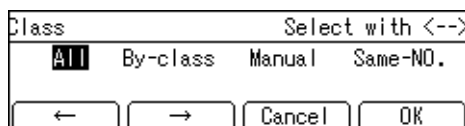

TPES570E

3 Press the **[OK]** key.

4 Enter the desired number of prints for the first original with the Number keys.

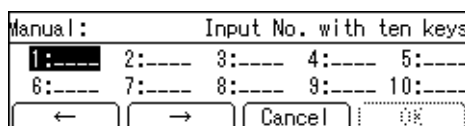

1

5 Press the **[#]** key.

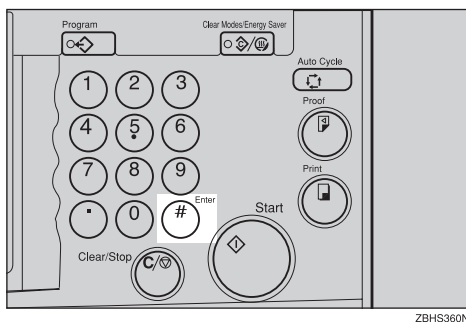

ZBHS360N

10 Press the **[Start]** key.

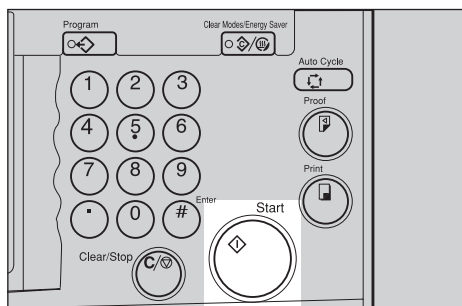

ZBHS280N

6 Enter the desired number of prints for the second original with the Number keys.

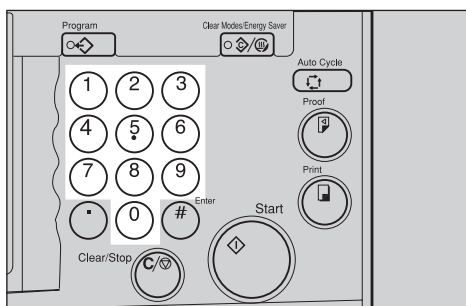

ZBHS310N

11 Check the image position of the trial or proof print.

Note

- If the image position is not correct, adjust it using the **[Image ⚙️]** keys (⇒ P.24 "Adjusting the Position of Printed Images").

7 Press the **[#]** key.

Note

- Repeat steps **6** and **7** for each original.
- The number of prints for up to 20 originals can be stored.

12 Press the **[Auto Cycle]** key.

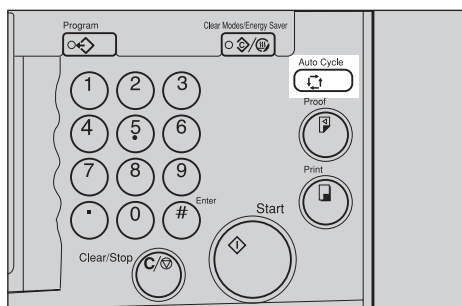

ZBHS490N

8 Press the **[OK]** key.

9 Set the first original face down on the exposure glass (contact glass).

13 Press the **[Print]** key.

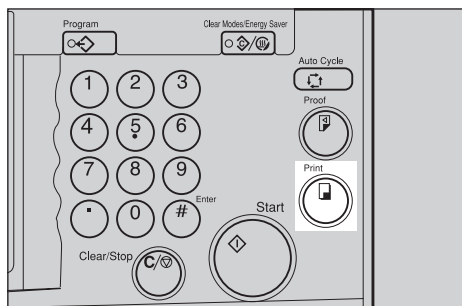

ZBHS320N

- After the first set is completed, set the second original on the exposure glass (contact glass) and press the **[Start]** key.

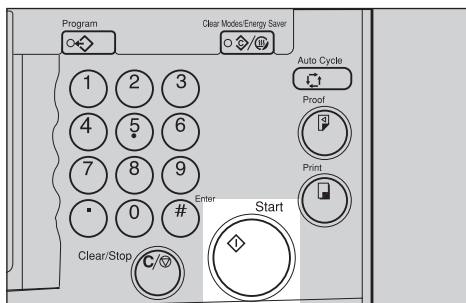

 **Note**

- Repeat step 14 until you have finished printing.

Class Mode—Making Fixed Numbers of Prints from the Same Original

1

Use the **[Class]** key to make sets of prints from the same original. The same numbers of prints are made for each set.

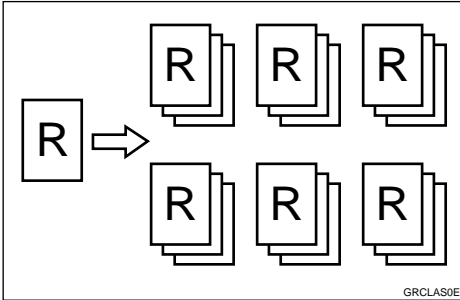

Note

- ❑ When you choose Class mode, Job Separation mode is automatically turned on. The job separator pulls the top sheet of the each set delivered to the paper delivery tray to mark the end of each printed set. The next cycle begins automatically. See ⇒ P.76 “Job Separation—Separating Printing Sets in the Paper Delivery Tray”.
- ❑ You can cancel Job Separation mode in Class mode with the user tools. See “Auto Separate” ⇒ P.146 “4. Mode Setting”.

1 Press the **[Class]** key.

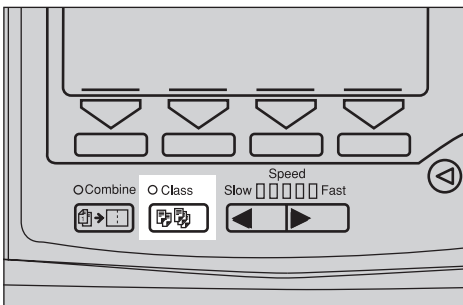

2 Select **[Same-NO.]** with the **[←]** or **[↵]** key.

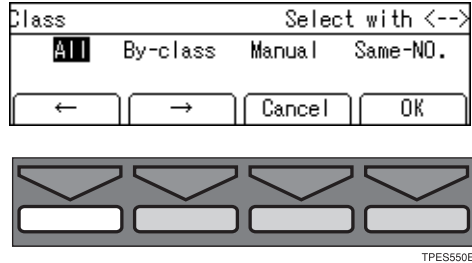

3 Press the **[OK]** key.

4 With the **Number** keys, enter the desired number of prints for each set.

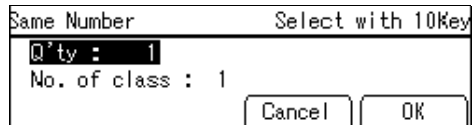

5 Press the **[#]** key.

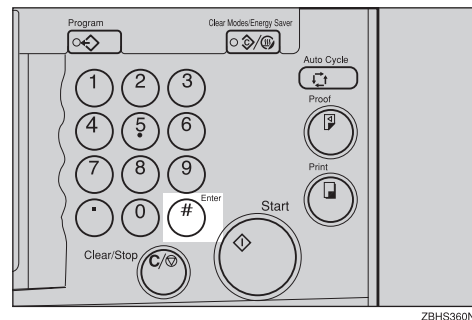

- 6** With the Number keys, enter the number of sets you wish to make.

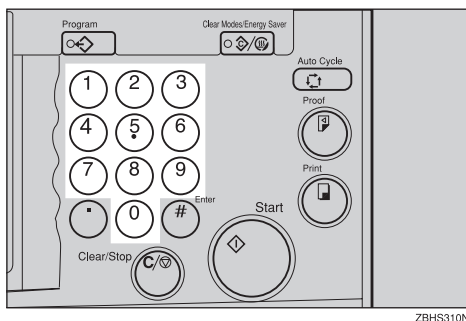

Note

- Up to 99 sets can be selected for an original.

- 7** Press the [OK] key.

- 8** Set one original on the exposure glass (contact glass) or in the optional document feeder.

- 9** Press the [Start] key.

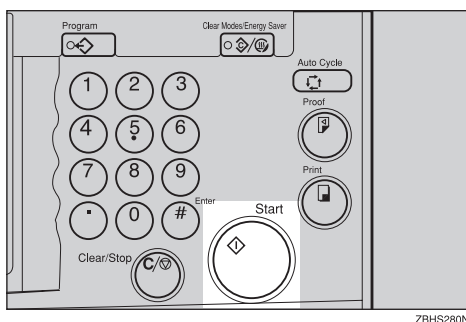

- 10** Check the image position is the trial or proof print.

Note

- If the image position is not correct, adjust it using the [Image ⌘] key. See ⇒ P.24 "Adjusting the Position of Printed Images".

- 11** Make your prints.

Combine Originals—Combining Originals into one Print

1 You can combine originals in two ways:

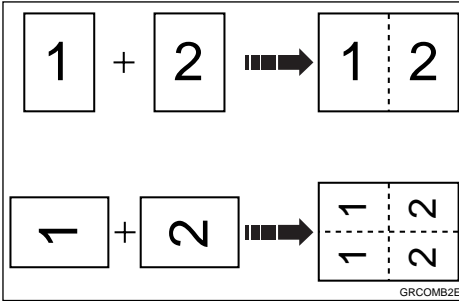

❖ **2 single-sided originals → 1 single-sided print with 2 images**

Combine two single-sided originals onto one single-sided print with the two images placed side-by-side.

❖ **2 single-sided originals → 1 single-sided print with 4 images**

Combine two single-sided originals onto one single-sided print with each image duplicated (total of four images).

 **Note**

- ❑ If your machine has the optional memory board, you can also use Memory Combine mode. See ⇒ P.124 “Memory Combine—Combining Originals into one Print with the Memory Board”.
- ❑ You can set the machine to cancel Combine Originals mode after finishing your print job with the user tools. See “Cancel Comb.” ⇒ P.146 “4. Mode Setting”.
- ❑ Any image closer than 10mm, 0.4" to the leading edge of the first original will not be printed. Any image closer than 4mm, 0.16" to the leading edge of the second original will also not be printed. When the image is too close to the leading edge, use copies of the originals with the image shifted at least 10mm, 0.4" for the first original (4mm, 0.16" for the second original) from the leading edge.
- ❑ You can select different image settings for the first and second original.
- ❑ Make sure that the paper feed side plates touch the paper lightly, and that the paper size and direction shown on the panel display match the size and direction of paper actually set in the Paper feed tray. Either case can cause the two original images not to appear at the proper position on prints.
- ❑ The following tables list the combinations that can be used with the Combine feature (2 single-sided originals → 1 single-sided print with 2 images).

❖ Metric version

		Original Size				
		A4	B5	A5	B6	A6
Paper Size	A3	100%	115%	141%	163%	200%
	B4	87%	100%	122%	141%	173%
	A4	71%	82%	100%	115%	141%
	B5	61%	71%	87%	100%	122%
	A5	50%	58%	71%	82%	100%

❖ Inch version









		Original Size	
		8 ¹ / ₂ " × 11"	5 ¹ / ₂ " × 8 ¹ / ₂ "
Paper Size	11" × 17"	100%	129%
	8 ¹ / ₂ " × 14"	77%	100%
	8 ¹ / ₂ " × 11"	65%	100%
	5 ¹ / ₂ " × 8 ¹ / ₂ "	50%	65%

□ The following tables list the combinations that can be used with the Combine feature (2 single-sided originals → 1 single-sided print with 4 images).

❖ Metric version

		Original Size						
		A3	B4	A4	B5	A5	B6	A6
Paper Size	A3	50%	58%	71%	82%	100%	115%	141%
	B4	-	50%	61%	71%	87%	100%	122%
	A4	-	-	50%	58%	71%	82%	100%
	B5	-	-	-	50%	61%	71%	87%
	A5	-	-	-	-	50%	58%	71%

❖ **Inch version**

		Original Size			
		11" × 17" 	8 1/2" × 14" 	8 1/2" × 11" 	5 1/2" × 8 1/2" 
Paper Size	11" × 17" 	50%	65%	65%	100%
	8 1/2" × 14" 	-	50%	50%	77%
	8 1/2" × 11" 	-	-	50%	77%
	5 1/2" × 8 1/2" 	-	-	-	50%

If a suitable reproduction ratio is not selected, images might not completely appear on prints.

 **Reference**

When you use the optional document feeder with this function, see ⇒ P.83 "Combine Printing with the Document Feeder".

1 Set the first original face down.

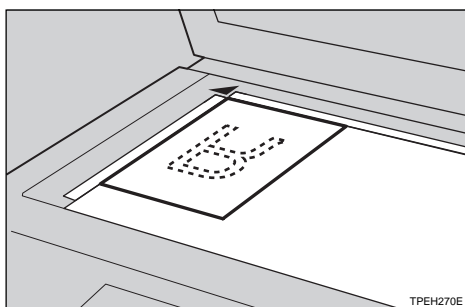

 **Note**

When you set original sideways () , the top should be toward the operation panel as shown above.

2 Enter the number of prints using the Number keys.

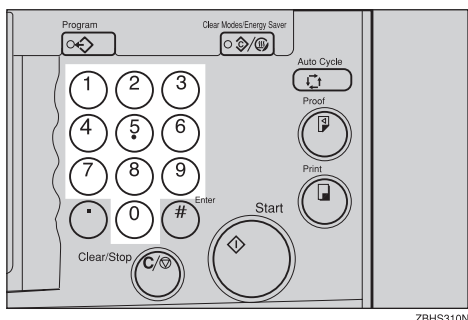

3 Check the print paper size and the reproduction ratio.

Note

- ❑ To have the machine choose a suitable ratio automatically, use Auto Magnification Selection mode. See ⇒ P.31 “Auto Magnification—Having the Machine Choose Reproduction Ratios”.

4 Press the [Combine] key.

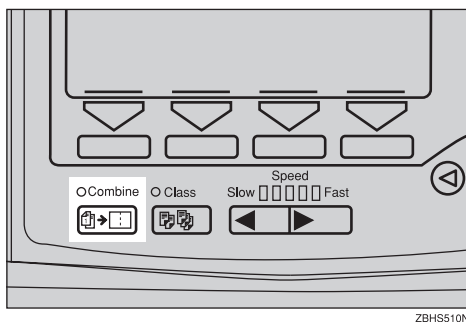

5 Select [Combine 2] or [Quadruple] with the [←] [→] or [◀] [▶] keys.

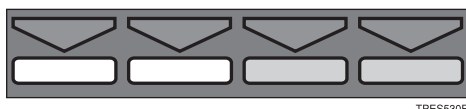
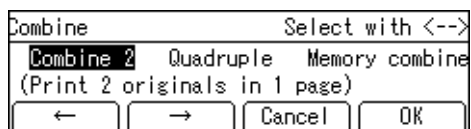

6 Press the [OK] key.

7 Press the [Start] key.

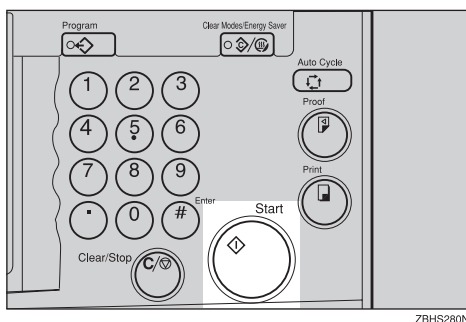

-
-
-
-
-
-
-
- 8** The beeper sounds after the first original has been stored. Set the second original face down.

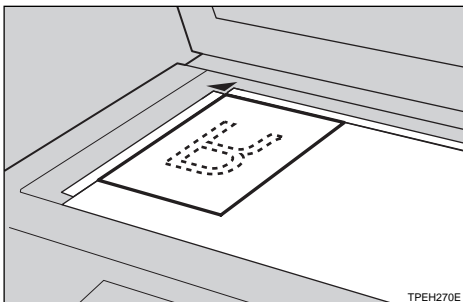

-
-
-
-
-
-
-
-
- 9** Press the **[Start]** key.

-
-
-
-
-
-
-
-
-
- 10** Check the image position of the trial or proof print.

 **Note**

- If the image position is not correct, adjust it using the **[Image ❖]** key (see ⇒ P.24 “Adjusting the Position of Printed Images”).

-
-
-
-
-
-
-
-
-
-
- 11** Make your prints.

Auto Combine Mode—Having Images Repeated on one Print

Preparation

To use this function, you have to select Auto Combine mode with the user tools. See “Combine” ⇒ P.146 “4. Mode Setting”.

You can have images repeated in two ways:

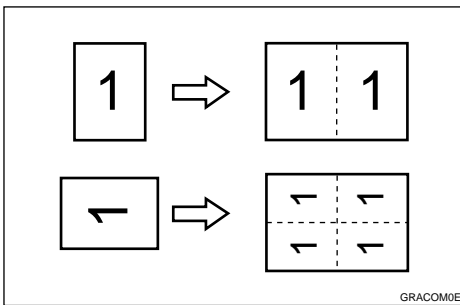

❖ 1 single-sided original → 1 single-sided print of 2 images

The original image is duplicated twice on one print.

❖ 1 single-sided originals → 1 single-sided print of 4 images

The original image is duplicated four times on one print.

Reference

See ⇒ P.62 “Combine Originals—Combining Originals into one Print” for details.

1 Set your original on the exposure glass (contact glass) or in the optional document feeder.

2 Enter the number of prints using the Number keys.

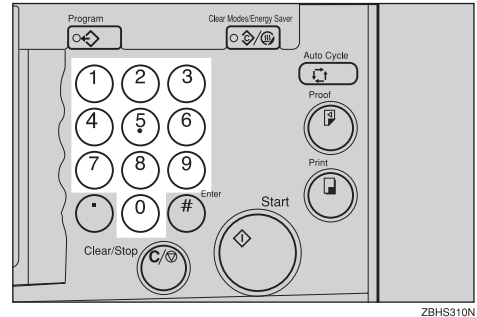

3 Check the print paper size and the reproduction ratio.

Note

- ❑ To have the machine choose a suitable ratio automatically, use Auto Magnification Selection mode. See ⇒ P.31 “Auto Magnification—Having the Machine Choose Reproduction Ratios”.

4 Press the [Combine] key.

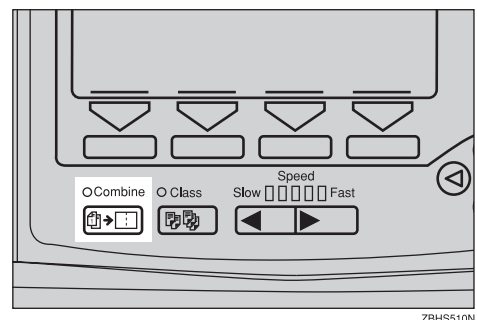

- 5** Select [Repeat 2] or [Repeat 4] with the [←] [→] or [◀] [▶] keys.

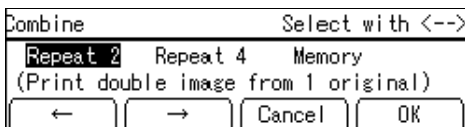

TPES530E

- 6** Press the [OK] key.

- 7** Press the [Start] key.

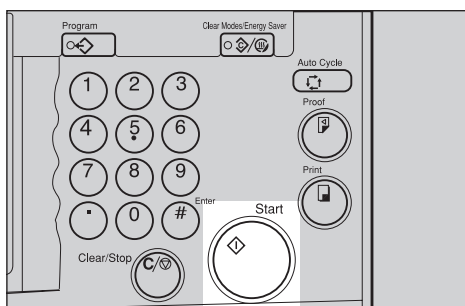

ZBHS280N

- 8** Check the image position of the trial or proof print.

Note

- If the image position is not correct, adjust it using the [Image ⚙️] key (see ⇒ P.24 "Adjusting the Position of Printed Images").

- 9** Make your prints.

Skip Feed Printing

If the backs of prints are dirty, you can increase the time between prints using the **[Skip Feed]** key. By default, when one sheet of paper is fed the drum rotates once. However, you can select the number of rotations of the drum. This gives you the chance to remove prints one by one from the paper delivery tray or insert one sheet of paper between two prints. If you use this function, you can also use paper longer than 432mm, 17.0" in spite of the maximum length limitations of paper.

Note

- Two rotations while one sheet of paper is fed is selected as a default. You can change this default setting with the user tools. See "No. of Skip Feed" ⇒ P.146 "4. Mode Setting".
- The maximum length of paper in Skip Feed mode is 460mm, 18.1".
- When you use paper longer than 432mm, 17.0", completed prints will not be delivered to the paper delivery tray properly, so lower the paper delivery end plate and receive completed prints by hand.

1 Set your original on the exposure glass (contact glass) or in the optional document feeder.

2 Press the **[Skip Feed]** key.

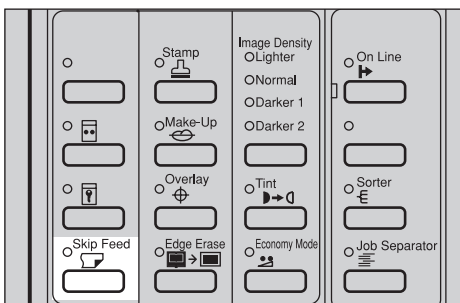

ZBHS530A

3 If necessary, select the number of rotations of the drum while one sheet of paper is fed with the **[←]** **[→]** or **[◀]** **[▶]** keys.

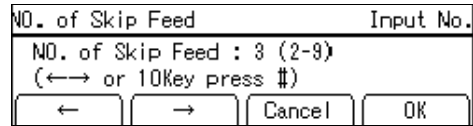

TPES530E

Note

- You can also select the number of rotations with the Number keys.
- You can select from 2 to 9 rotations.
- By default, the machine asks you to confirm the number of rotations. You can have this step omitted by adjusting the user tool settings. See "No. of Skip Feed" ⇒ P.146 "4. Mode Setting".

4 Press the **[OK]** key.

5 Press the **[Start]** key.

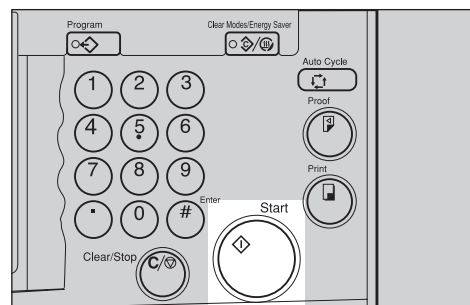

ZBHS280N

6 Check the image position of the trial or proof print.

 **Note**

- If the image position is not correct, adjust it using the **[Image ❄]** key (see ⇒ P.24 “*Adjusting the Position of Printed Images*”).

7 **Make your prints.**

 **Note**

- After printing is completed, the Skip Feed setting returns to the default.

Programs—Storing Your Print Settings in Memory

You can store up to 9 frequently used print job settings in machine memory and recall them for future use.

Note

- The stored programs are not cleared when you turn off the main switch.
- The stored programs cannot be deleted. If you want to change a stored program, overwrite it.

Storing a Program

- 1** Set the print settings you want to put into memory.
- 2** Press the **[Program]** key.

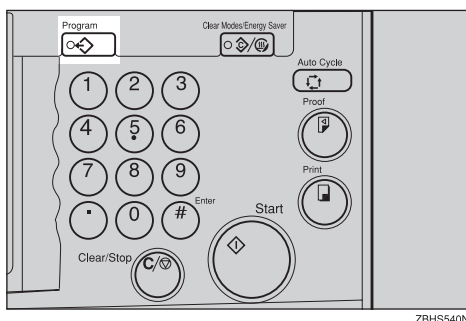

- 3** Select **[Store]** with the **[→]** or **[▷]** key.

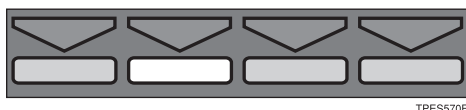
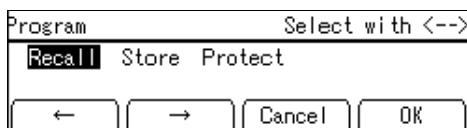

- 4** Press the **[OK]** key.

Note

- The program numbers (1 to 9) will be displayed in the panel display panel.
- If a user program has been protected, that program number will not appear in the panel display. To change a protected user program, see ⇒ P.72 "Protecting a Program".
- If all the user programs have been protected, you cannot store any settings. Press the **[Cancel]** key.

- 5** Select the program number you want to store the settings in with the **[←]** **[→]** or **[◀]** **[▶]** keys.

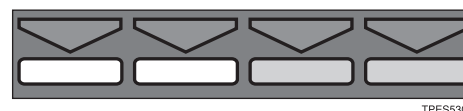
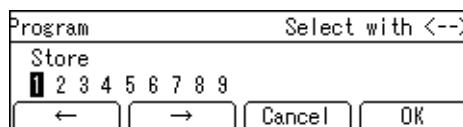

Note

- You can also select the program number with the Number keys.

- 6** Press the **[OK]** key.

Note

- If this program number is already used, the machine asks whether you wish to overwrite it or not. Press the **[Yes]** or **[No]** key.

Recalling a Program

1 Press the [Program] key.

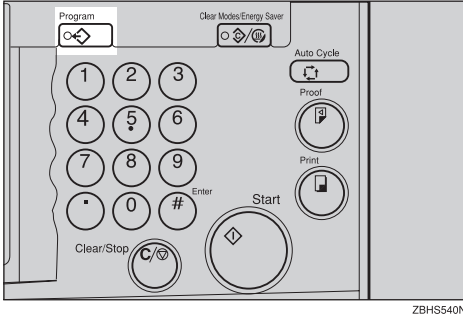

2 Make sure that [Recall] is selected.

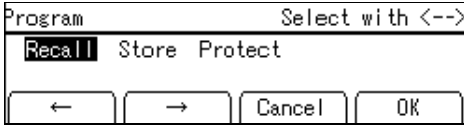

3 Press the [OK] key.

Note

- Programs that have been stored beforehand are represented by a number.

4 Select the program number you want to recall with the [←] [→] or [◀] [▶] keys.

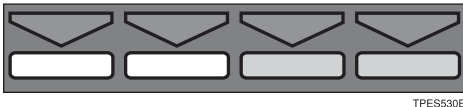
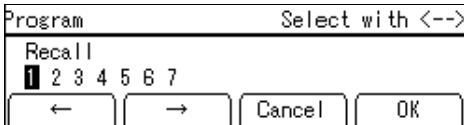

Note

- You can also select the program number with the Number keys.

5 Press the [OK] key.

6 Set your original on the exposure glass (contact glass) or in the optional document feeder.

7 Press the [Start] key.

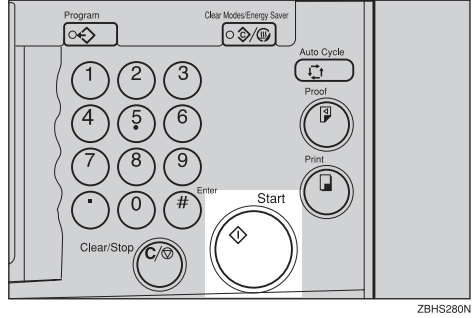

Protecting a Program

If you want to prevent someone from writing over your program, do the following.

1 Press the [Program] key.

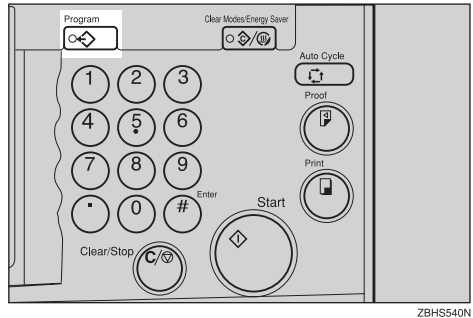

2 Select [Protect] with the [←] or [◀] key.

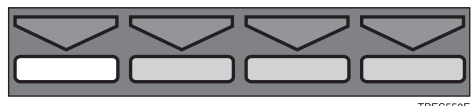
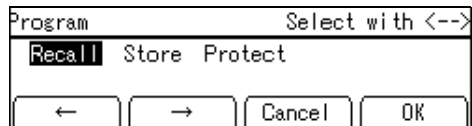

3 Press the [OK] key.

- 4 Select the program number you want to protect with the [←] [→] or [◀] [▶] keys.

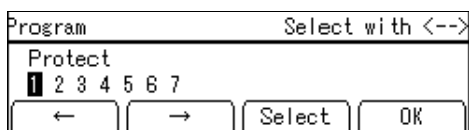

TPES530E

Note

- Already protected program numbers are shown with a black background (e.g. 1).
- You can also select the program number with the Number keys.

- 5 Press the [Select] key.

- 6 Press the [OK] key.

Removing Program Protection

- 1 Press the [Program] key.



ZBHS540N

- 2 Select [Protect] with the [←] or [▶] key.

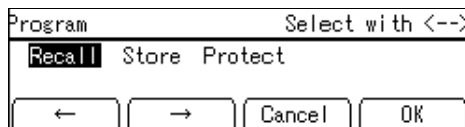

TPES550E

- 3 Press the [OK] key.

- 4 Select the program number you want to remove protection from with the [←] [→] or [◀] [▶] keys.

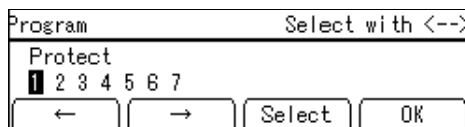

TPES530E

Note

- Already protected program numbers are shown with a black background (e.g. 1).
- You can also select the program number with the Number keys.

- 5 Press the [Cancel] key.

- 6 Press the [OK] key.

Security Mode—Printing Confidential Documents

1

This function prevents others from making prints of confidential documents from the master. For example, if you want to print some documents with sensitive information, use this function after making your prints so that nobody can access that master again.

1 Make your prints.

2 Press the **[Security]** key.

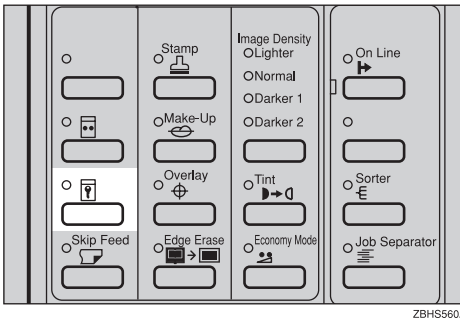

3 Press the **[Yes]** key.

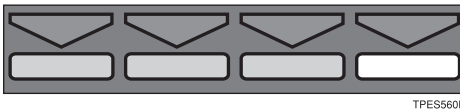
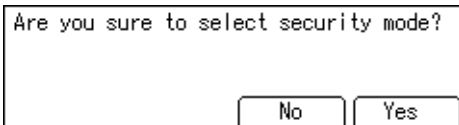

Note

- If you press the **[Proof]** key or the **[Print]** key after finishing one print job, the machine lets you know that you cannot make prints. Press the **[Exit]** key.
- You cannot cancel Security mode even if you turn off the main switch.

- If you make the next master, Security mode is canceled.
- You cannot pull out the drum unit before making the next master.

Quality Start Mode— Regaining Image DensityWhen Drum Ink Dries

If the machine is not used for a long period of time or you change the colour drum unit, the ink on the drum might dry causing print quality to deteriorate. To solve this problem, you can have the machine carry out a few idle spins of the drum before a print run. This will restore image quality and save you having to make a repeat print run.

You can use this feature in two ways:

❖ Manual Quality Start

Choose Quality Start for the next print run manually using the **[Quality Start]** key.

❖ Auto Quality Start

Have the machine check automatically how long ago the machine was used before each print run. If the machine has not been used for a long time, Quality Start will be used for the print job. By default, Auto Quality Start mode is on. You can turn it off with the user tools. See “Setting Q.start” ⇒ P.146 “4. Mode Setting”.

📌 Note

- ❑ You can change the number of spins in Manual Quality Start mode with the user tools. See “Idling for Q.start” ⇒ P.146 “4. Mode Setting”.
- ❑ You can change the number of spins after the fixed time period has passed in Auto Quality Start mode with the user tools. See “No. of Q.start” ⇒ P.146 “4. Mode Setting”.

Using Quality Start Manually

1 Press the **[Quality Start]** key.

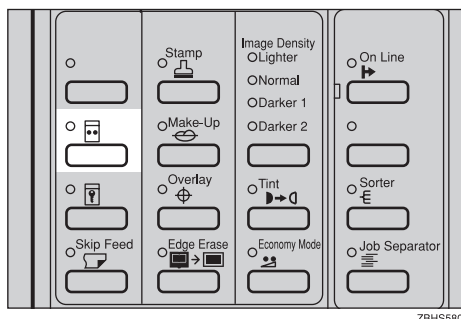

2 Set your original on the exposure glass (contact glass) or in the optional document feeder.

3 Press the **[Start]** key.

The drum unit idles.

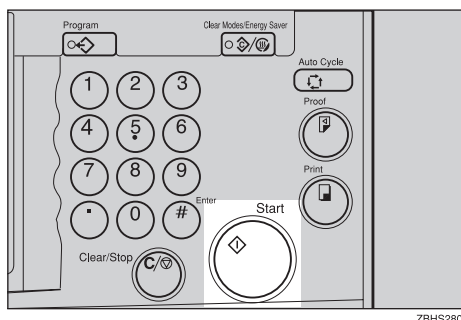

4 Make your prints.

Job Separation—Separating Printing Sets in the Paper Delivery Tray

1

The print on the top of each print set on the paper delivery tray is pulled by the job separator. This function is useful when you make 2 or more print sets.

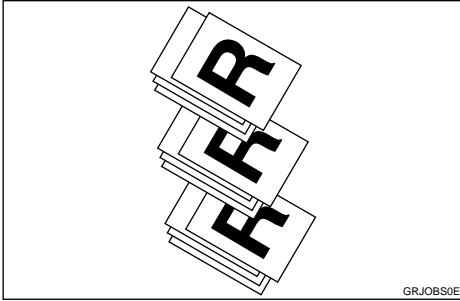

⚠ CAUTION:

- While printing, do not touch the belt at the end of the paper delivery tray or the job separator. Otherwise you might be injured.

📌 Limitation

- In Job Separation mode, the following limitations apply:

❖ **Metric version**

Minimum paper size	Maximum paper weight	Paper delivery tray capacity
Length: 210mm Width: 128mm	127.9g/m ²	600 sheets (64g/m ²)

❖ **Inch version**

Minimum paper size	Maximum paper weight	Paper delivery tray capacity
Length: 8.3" Width: 5.1"	34 lb	600 sheets (17 lb)

📝 Note

- When you use thin paper, it is not recommended to use Job Separation mode. The job separator might tear the paper.
- If the job separator touches the print image, completed prints might be marked. In this case, it is not recommended to use Job Separation mode.
- When you do not use Job Separation mode, you can select the machine condition after each print set is fed out to the paper delivery tray with the user tools. See “Auto Class” ⇒ P.146 “4. Mode Setting”.

1 Press the **[Job Separator]** key.

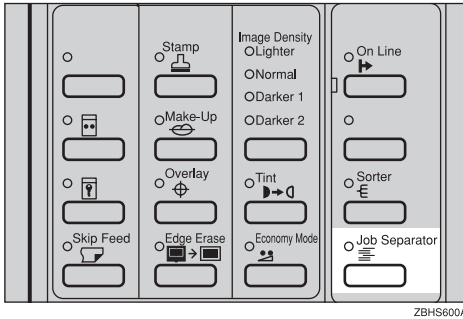

1

2 Make your prints.

Note

- After the last page of each print set is fed out to the paper delivery tray, the job separator pulls the last sheet of each group in Job Separation mode. The next cycle begins.

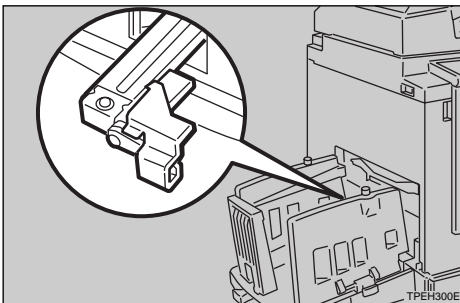

Conserving the Master

1

The machine automatically changes the master length depending on the paper size you use. This saves both master and ink.

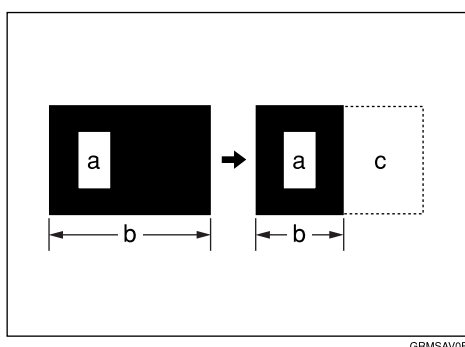

a = Images on the master



b = Masters

c = Area that you can save master and ink

! Limitation

- The optional document feeder is required.

✎ Note

- This function is turned on when you use A4 , 8¹/₂" × 11"  or B5  paper and you set 2 or more originals in the optional document feeder.
- This function does not apply to the last page.
- You can cancel Master Saving mode with the user tools. See "Master length" ⇒ P.146 "4. Mode Setting". You can also save master using the optional A4, 8¹/₂" × 11" drum. See ⇒ P.90 "Changing the Drum Size".



On Line Printing

On Line printing allows you to use this machine as a PC printer.

! Limitation

- The PC controller is required. For details, refer to the PC controller manual.



📖 Note

- Before printing onto A5 , 5 1/2" x 8 1/2" , or non-standard size paper, you need to select the paper size with the [Ppr.Size] key.
- When printing onto thick paper, thin paper or special kinds of paper from the Paper feed tray, select the paper type before pressing the [On Line] key. See => P.42 "Printing onto Various Kinds of Paper".

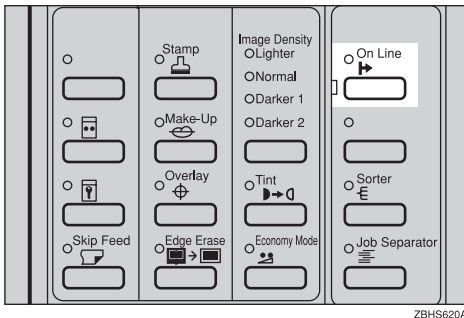
1 Press the [On Line] key.



ZBHS620A

When printing onto A5 , 5 1/2" x 8 1/2" , or non-standard paper sizes

1 Press the [Ppr.Size] key.

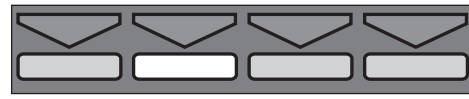
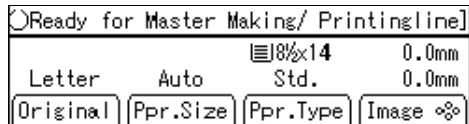

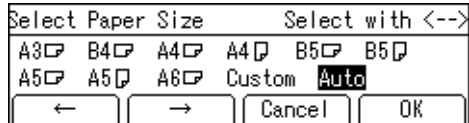

TPES570E

2 Select A5 , 5 1/2" x 8 1/2" , or Custom (non-standard) with the [←] or [→] key.



TPES30E

3 Press the [OK] key.

When printing onto standard paper sizes or sizes other than A5 , 5 1/2" x 8 1/2" 

1 Refer to the PC controller manual.

2. Optional Functions

Optional Document Feeder

Insert a stack of originals in the document feeder. It will be fed automatically.

Originals















Setting the following originals in the document feeder might cause original misfeeds or damage to the originals.

Set the following kinds of originals on the exposure glass (contact glass):

- Originals heavier than 105g/m², 27 lb
- Originals lighter than 52g/m², 14 lb
- Originals smaller than 105mm × 128mm, 4.2" × 5.1"
- Originals larger than 297mm × 864mm, 11.6" × 34.0"
- Stapled or clipped originals
- Perforated or torn originals
- Curled, folded, or creased originals
- Originals with any kind of coating, such as thermal fax paper, art paper, aluminum foil, carbon paper, or conductive paper
- Bound originals such as books
- Damaged originals
- Originals with glue on them
- Pasted originals
- Originals written in pencil
- Thin originals that have low stiffness
- Originals with index tabs

- Transparent originals such as OHP transparencies or translucent paper

The following original sizes set in the document feeder can be detected.

Metric version	A3  , B4  , A4   , B5   , A5  
Inch version	11" × 17"  , 8 ¹ / ₂ " × 14"   , 8 ¹ / ₂ " × 11"   , 5 ¹ / ₂ " × 8 ¹ / ₂ "  

Under the following conditions, the machine might not detect the original. In this case, select the original image area with the **[Edge Erase]** key. See ⇒ P.41 “Edge Erase—Erasing Edge Margins”.

- When you use originals with index tabs.
- When you use OHP transparencies or translucent paper.
- When you use dark originals.
- When you use originals with solid images.
- When you use originals other than the sizes described above.

Note

- Set originals after correction fluid and ink have completely dried. Not taking this precaution could mark the exposure glass (contact glass) and cause marks to be printed.

2

For standard printing functions, set originals as shown below.

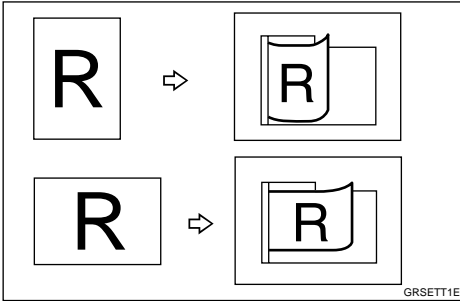

If you have the optional memory board and the original is set in a different direction from the print paper, the machine automatically rotates the original image by 90° to match the print paper direction.

You cannot set originals of different sizes at the same time.

When you use thin originals, set one original at a time in the document feeder or set them on the exposure glass (contact glass).

The first 10mm, 0.4", of the leading edge and the last 2mm, 0.08" of the trailing edge cannot be printed. Make sure the leading edge margin is at least 10mm, 0.4", and the trailing edge margin is at least 2mm, 0.08".

Do not stack originals above the limit mark.

Setting Originals in the Document Feeder

- 1** Adjust the guide to the original size.
- 2** Insert the aligned originals face up into the document feeder.

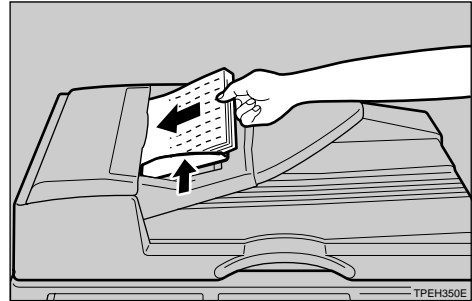

! Limitation

- Approximately 30 originals (80g/m², 21 lb) can be inserted at one time in the document feeder. The first (top) original will be fed first.

Note

- To avoid a multi-sheet feed, shuffle the originals before setting them in the document feeder.
- The guides must fit snugly against both sides of the stack.

- 3** Adjust any print settings as necessary, then press the **[Start]** key.

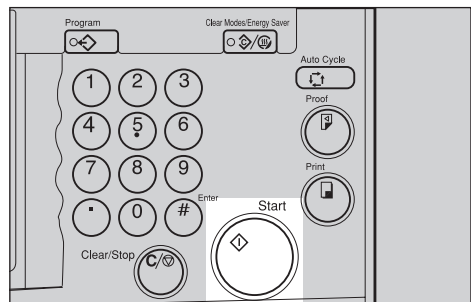

4 Make your prints.

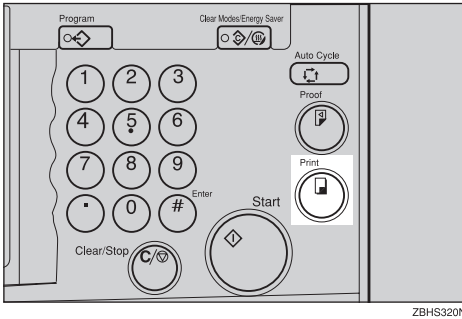

Note

- If the next original has been set in the document feeder before the machine stops, that original is fed automatically and a trial print is delivered to the paper delivery tray after the print of the first original is completed. Check the image position of the trial print of the next original. If necessary, make proof prints using the **[Proof]** key to check the image position again.

Combine Printing with the Document Feeder

Reference

See ⇒ P.62 “Combine Originals—Combining Originals into one Print” for details.

1 Insert the 2 originals face up.

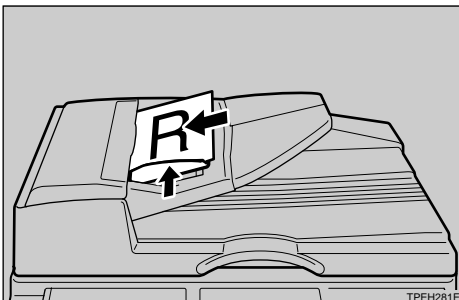

Note

- The first original will be printed on the left side of the paper.

2 Enter the number of prints with the Number keys.

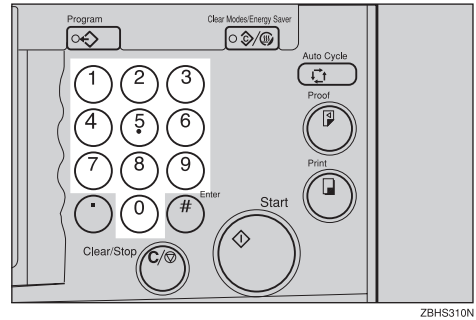

3 Check the print paper size and the reproduction ratio.

Note

- To have the machine choose a suitable ratio automatically, use Auto Magnification Selection mode. See ⇒ P.31 “Auto Magnification—Having the Machine Choose Reproduction Ratios”.

4 Press the [Combine] key.

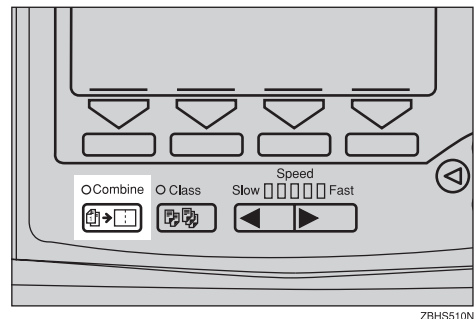

5 Select [Combine 2] or [Quadruple] with the [←][→] or [◀][▶] keys.

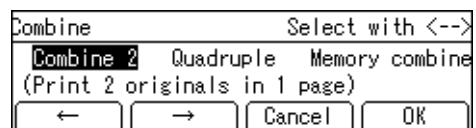

6 Press the [OK] key.

7 Press the [Start] key.

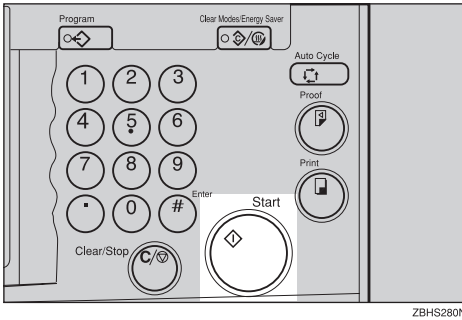

8 Check the image position of the trial or proof print.

Note

- If the image position is not correct, adjust it using the [Image] key (see ⇒ P.24 “Adjusting the Position of Printed Images”).
- After the first original has been stored, the second original is fed.
- If you set only one original, the beeper sounds after the first original has been scanned in. Set the second original and the any print settings you require. Then press the [Start] key.

Manual Class Mode with Two or More Originals Using the Document Feeder

Reference

See ⇒ P.57 “Manual Class Mode with 2 or More Originals—Making Variable Numbers of Prints from Different Originals”.

1 Press the [Class] key.

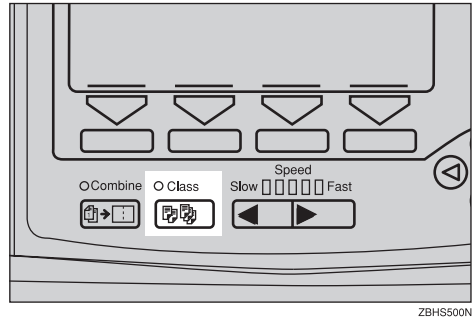

2 Select [Manual] with the [→] or [▷] key.

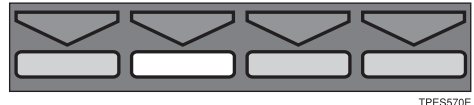
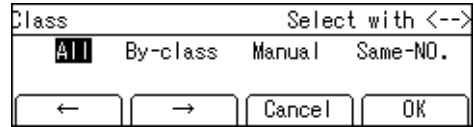

3 Press the [OK] key.

4 Enter the desired number of prints for the first original with the Number keys.

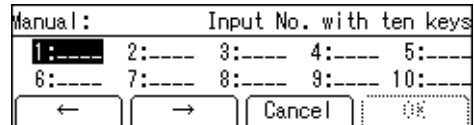

5 Press the [#] key.

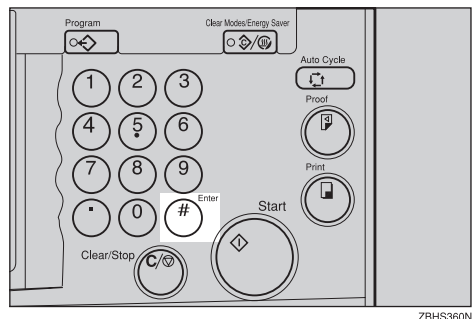

- 6** Enter the desired number of prints for the second original with the Number keys.

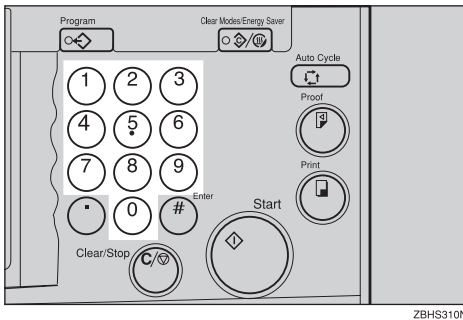

- 7** Press the [#] key.

Note

- Repeat steps **6** and **7** for each original.
- The number of prints for up to 20 originals can be stored.

- 8** Press the [OK] key.

- 9** Set your originals face up in the document feeder.

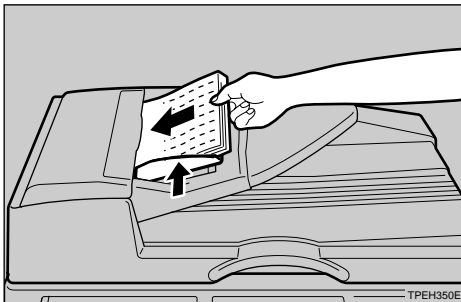

Note

- The originals are fed from the top of the stack. Make sure that the originals are set in the correct sequence with the first original on the top.

- 10** Press the [Start] key.

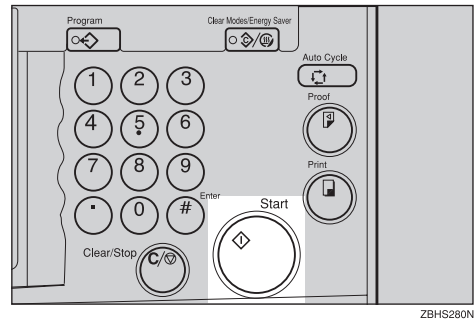

- 11** Check the image position of the trial or proof print.

Note

- If the image position is not correct, adjust it using the [Image ⚙️] key (see ⇒ P.24 "Adjusting the Position of Printed Images").

- 12** Press the [Auto Cycle] key.

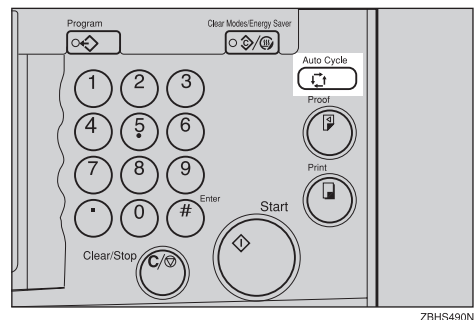

Note

- In Auto Cycle mode, printing starts automatically after a trial print is delivered.

- 13** Press the [Print] key.

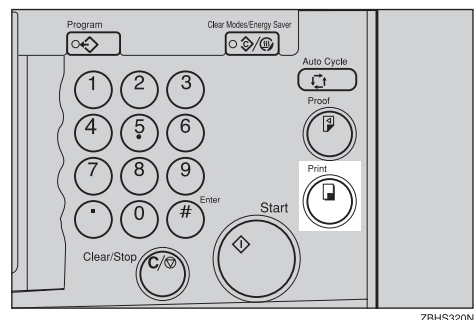

Colour Printing Using the Optional Colour Drum

Colour drum units are available as options in addition to the standard black unit. For making colour prints, a separate drum unit is necessary for each colour.

Note

- If the ink on the colour drum dries, use the Quality Start function. See ⇒ P.75 “Quality Start Mode— Regaining Image Density When Drum Ink Dries”.

Making colour Prints

- 1 Make sure that the colour Drum indicator is lit.

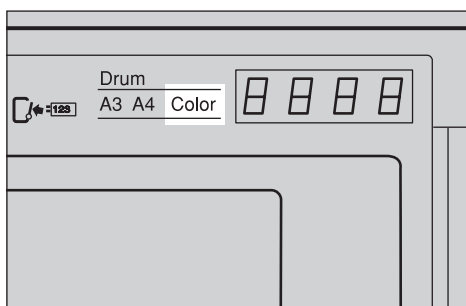

- 2 Press the **[Start]** key.
- 3 Check the image position of the trial or proof print.

Note

- If the image position is not correct, adjust it using the **[Image ⌘]** key (see ⇒ P.24 “Adjusting the Position of Printed Images”).

- 4 Make your prints.

Changing the Colour Drum Unit

- 1 Open the front door.
- 2 Lower the drum unit lock lever B1.

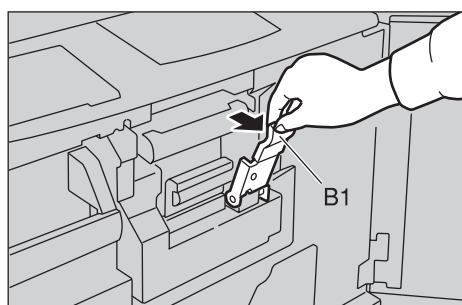

Note

- Make sure the green light beside the drum unit lock lever is on before sliding out the drum. If the light is off, close the front door, wait for five seconds and then open the front door.

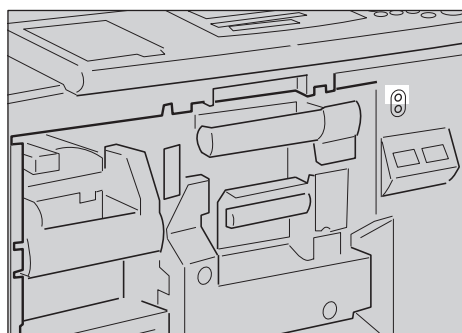

- 3** Pull out drum unit handle B2 slowly.

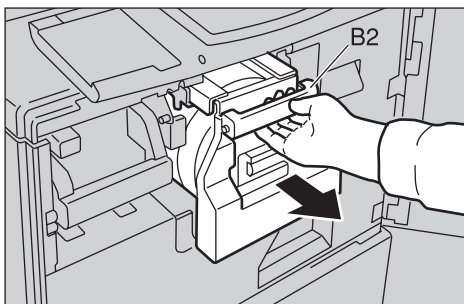

- 4** Lift upper drum stay B3 a little to unlock the drum unit, then pull out the drum unit while holding drum unit handle B2 and upper drum stay B3.

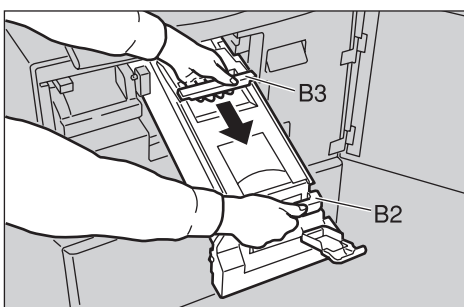

Important

- Be careful not to let the drum unit fall.

- 5** Make sure the optional colour drum lock is securely set.

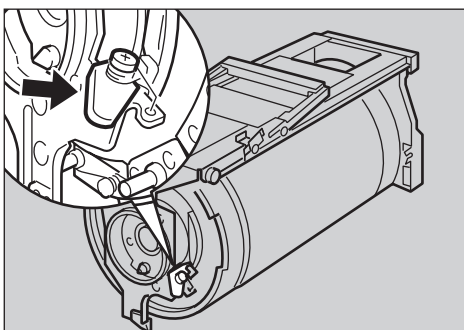

- 6** Insert the colour drum unit along the guide rail.

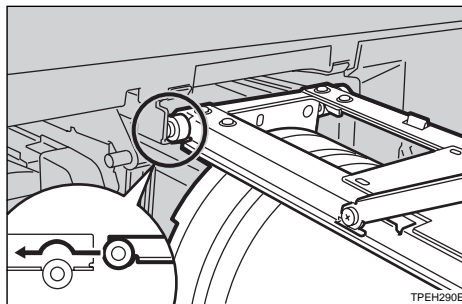

- 7** Lower drum unit lock lever B1 of the inserted drum.

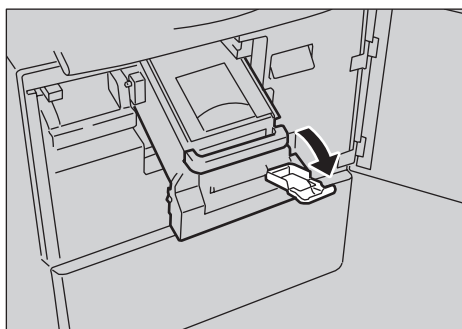

- 8** Slide in the drum unit until it locks in position.

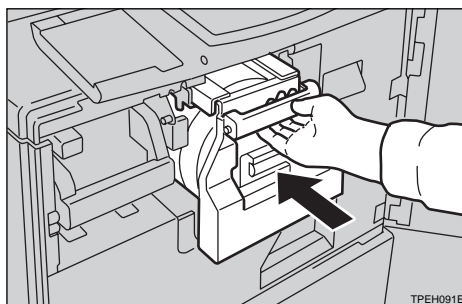

9 Lift drum unit lock lever B1.

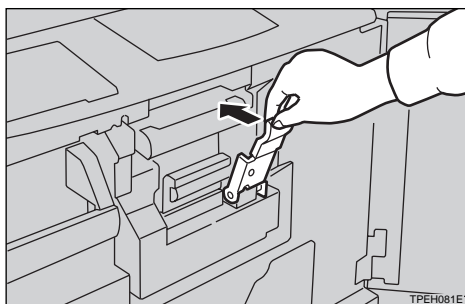

10 Close the front door.

Note

- Make sure that the **Open Cover/Unit** indicator turns off, and the **colour Drum** indicator lights.

Printing in Two colours

After printing in one colour, you can print in another colour on the same side of the print.

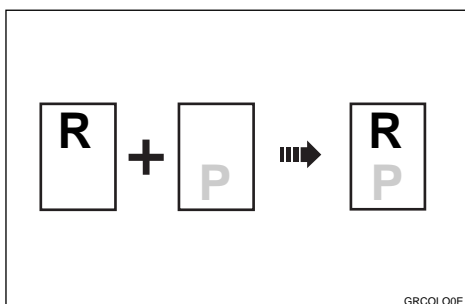

Note

- Leave the prints for a while before printing on them again to let the ink dry.
- If the prints are not dry, the paper feed roller might become dirty. In this case, wipe the roller with a cloth.
- You cannot print in two colours at one time.
- You cannot place paper that has already been printed on in tray 1 or tray 2. Place it in the Paper feed tray instead.

1 Prepare the two originals. Set the first original on the exposure glass (contact glass).

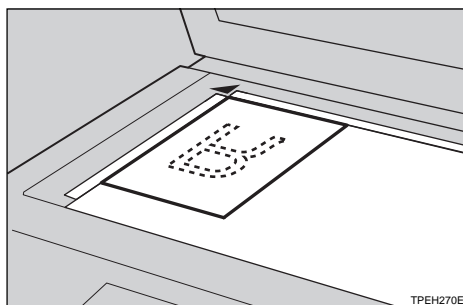

2 Enter the number of prints with the Number keys.

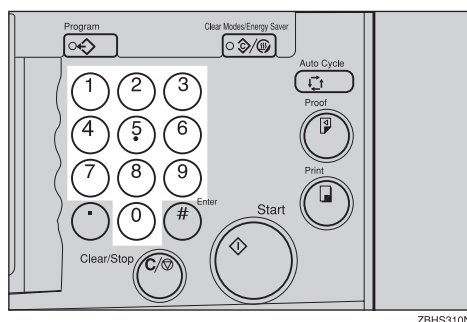

3 Press the [Start] key.

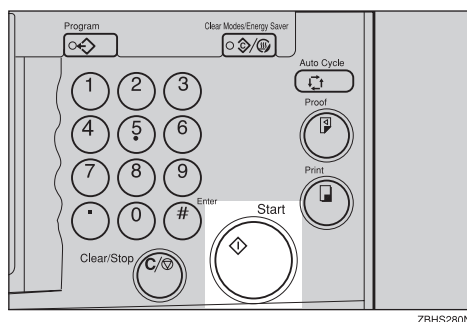

- 4** Check the image position of the trial or proof print.

 **Note**

- If the image position is not correct, adjust it using the **[Image ⌘]** key (see ⇒ P.24 “Adjusting the Position of Printed Images”).

- 5** Press the **[Print]** key.

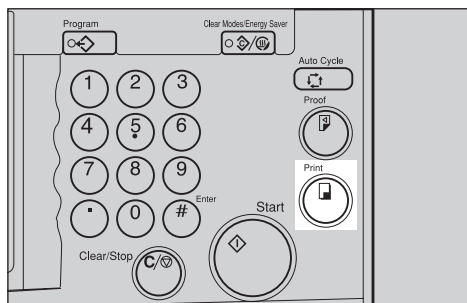

ZBHS320N

- 6** Remove the prints from the paper delivery tray and set them on the Paper feed tray again as shown in the illustration.

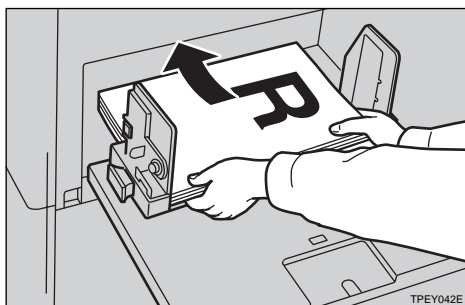

TPEY042E

- 7** Change the drum unit. See ⇒ P.86 “Changing the Colour Drum Unit”.

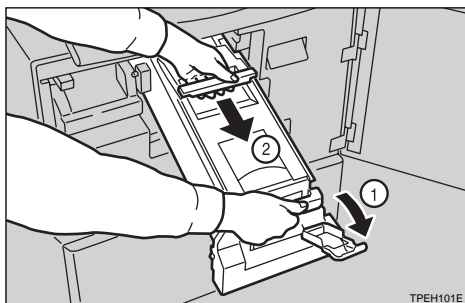

TPEH101E

Changing the Drum Size

To save costs on master rolls and ink, you can shorten the length of each master by changing to an optional smaller drum.

2

Printing Area (At 23°C/73°F, 65% RH)

❖ Metric version

A3 drum	More than 290 × 419mm, 11.4" × 16.4"
A4 drum	More than 290 × 200mm

❖ Inch version

11" × 17" drum	More than 290 × 409mm, 11.4" × 16.1"
8 ¹ / ₂ " × 11" drum	More than 11.4" × 7.8"

Master Cut Length

A3 drum...320mm × 530mm, 12.5" × 20.9", 200 masters/roll

11" × 17" drum...320 × 540mm, 12.5" × 21.3", 200 masters/roll

Optional A4 8¹/₂" × 11" drum...320mm × 325mm, 12.5" × 12.8", 330 masters/roll

Note

- ❑ For how to change the drum unit, see⇒ P.86 "Changing the Colour Drum Unit".

Image Rotation—Rotating Original Images

When the direction in which your original is set is different from that of the paper, and your machine is equipped with the optional memory board, the machine automatically rotates the original image by 90° to match the paper direction.

Note

The following tables list the combinations that can be used in Image Rotation mode.









❖ Metric version

Original	A3 	B4 	A4 	A4 	B5 	B5 	A5  ☆	A5  ☆
A4 	--	--	--	★	--	★	--	★
A4 	★	★	★	--	★	--	★	--
B5 	--	--	--	★	--	★	--	★
B5 	★	★	★	--	★	--	★	--
A5 	--	--	--	★	--	★	--	★
B6 	--	--	--	★	--	★	--	★

★: The machine automatically rotates the original image by 90° to match the paper direction.

☆: Set these originals in the optional document feeder.

❖ Inch version

Original	11" × 17" 	8 ¹ / ₂ " × 14" 	8 ¹ / ₂ " × 11" 	8 ¹ / ₂ " × 11" 	5 ¹ / ₂ " × 8 ¹ / ₂ "  ☆	5 ¹ / ₂ " × 8 ¹ / ₂ "  ☆
8 ¹ / ₂ " × 11" 	--	--	--	★	--	★
8 ¹ / ₂ " × 11" 	★	★	★	--	★	--
5 ¹ / ₂ " × 8 ¹ / ₂ " 	--	--	--	★	--	★

★: The machine automatically rotates the original image by 90° to match the paper direction.

☆: Set these originals in the optional document feeder.

 **Note**

- If you select Zoom mode, non-standard size originals or paper, the image will not be rotated.
- It takes longer than usual to make masters in Image Rotation mode.
- You can cancel Image Rotation mode with the user tools. See “Auto Rotation” ⇒ P.146 “4. Mode Setting”.

Make-up Printing Features

Make-up mode enables you to do more than just make an exact copy of the original. A variety of editing and image processing functions allow you to quickly and easily customize your prints.









Limitation

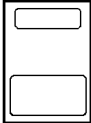

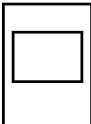

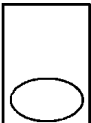

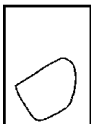
- The memory board option is required for this feature.

Main Features

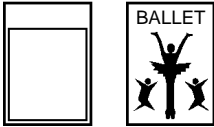

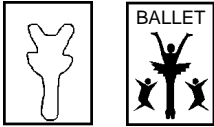

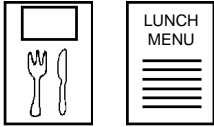
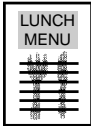
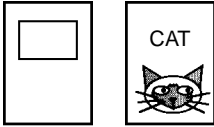

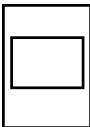

Command sheets allow you to create special effects without cutting and pasting—up to 4 commands can be given for an original. By combining Make-up functions and printing with different colour drums, you can create a variety of printing effects.

Make-up Modes for Designated Areas

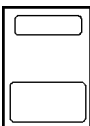
Mode		Sample	
Designated Area		Command sheet/Original (Closed area method)	Print
1.	Letter mode	 	
2.	Photo mode	 	
3.	Delete Area mode	 	
4.	Outline mode	 	

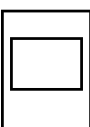
Mode		Sample	
Designated Area		Command sheet/Original (Closed area method)	Print
5.	P./N. mode (Positive Negative mode)		
6.	Solid mode (Image Pattern mode)		
7.	All Page Pattern mode (Area Pattern mode)		
8.	All + Outline (Image Outline and Area Pattern mode)		

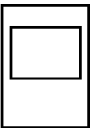
Make-up Modes for Outside Designated Areas

Mode		Sample	
Undesignated Area		Command sheet/Original	Print
1.	Letter mode: The area outside designated areas is printed in Letter mode.	 	
2.	Photo mode: The area outside designated areas is printed in Photo mode.	 	
3.	Save Area mode: The area outside the designated areas is deleted.	 	
4.	Outline mode: The area outside the designated area is printed in Outline mode.	 	

 **Note**

- In Make-up mode, commands must be given for both designated areas and areas outside the designated areas.

Background Patterns

A total of 164 background patterns is available in Make-up mode:

- 40 basic patterns
- 40 patterns similar to the basic patterns but with patterns elements at 4 times the size.
- 90° rotations of all the basic and enlarged patterns.
- 4 registered user patterns.

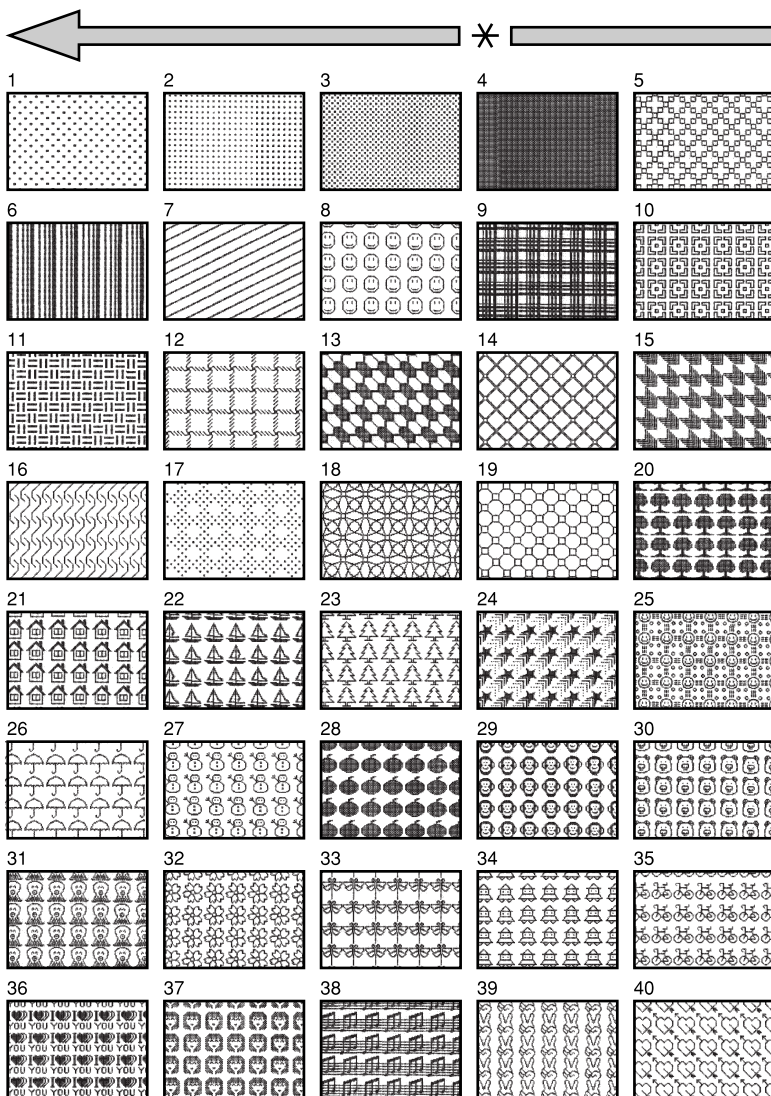

GCMAKE0E

*: Paper Feed Direction

 **Note**

- The basic patterns are numbered 1 to 40.
- You can make your own make-up background patterns with the user tools.
See ⇒ P.168 *"5-15 Make/Chg. Pattern"*.

Command Sheets for Make-Up Printing

Command sheets are fed first so that the machine can recognize the areas of the original which are to be edited as designated areas.

2

Command Sheets

The command sheet is a sheet of paper for designating areas to be edited. Command sheets must be made on white or translucent paper, and should be the same size as the original.

You can designate areas within the following limits:

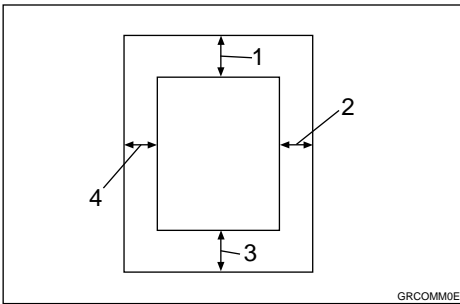

- 1. 5mm, 0.2"
- 2. 0mm, 0"
- 3. 0mm, 0"
- 4. 0mm, 0"

Note

- Poor quality paper (such as newsprint, recycled paper, etc.) should not be used for command sheets because any dark spots or streaks will be read as designated areas.
- Do not use blotting paper or other absorbent paper for command sheets because ink might leak through the paper and get the exposure glass (contact glass) dirty.

Making a Command Sheet

There are two ways of designating areas: the diagonal line method and the closed area method.

Features

- You can combine up to 4 command sheets when making a master.

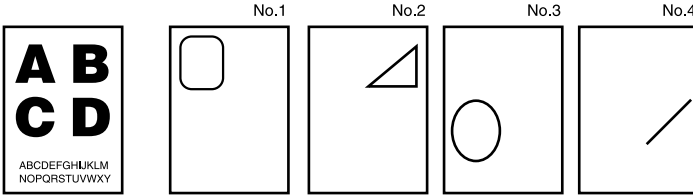

- You cannot use both the closed and diagonal line method on the same command sheet.

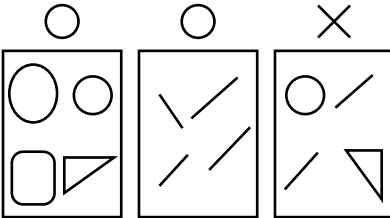

- There is no limit to the number of areas you can designate on a single command sheet.

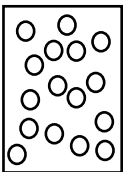

- If designated areas on two or more command sheets overlap, the last command sheet will apply for the overlapping portion.

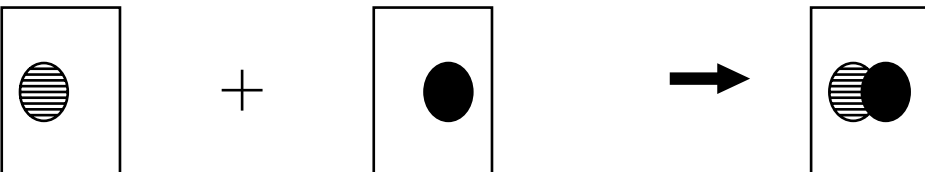





- If you use Outline mode for letter images with a thickness of less than 3mm, 0.12", the print image might come out as expected.

 **Notes**

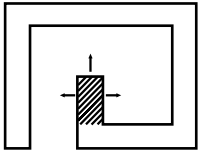
The image might differ depending on how the designated area is drawn, so remember the following when making the command sheet:

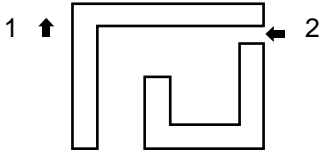
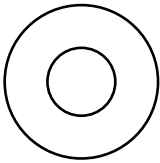
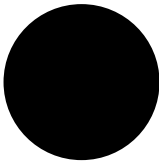
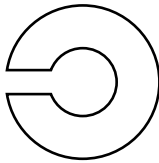
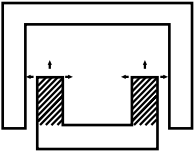
2

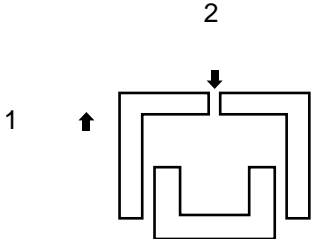
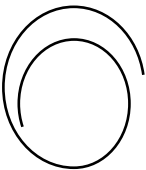
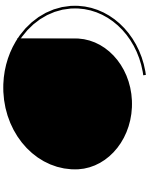
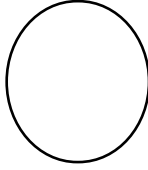
Designated area	Area recognized	Preferred designated area
<p>Part of the designated area is surrounded by 3 sides of the entire area.</p> 		<p>Make a space of at least 2mm, 0.08", in front of the area surrounded by 3 sides (relative to the feed direction).</p>  <p>1, 2 = 2mm, 0.08"</p>
<p>Double line pattern.</p> 	<p>Only the outer line is recognized.</p> 	<p>Make a gap of at least 2mm, 0.08" in width.</p> 
<p>The designated area is surrounded by 3 sides of another designated area.</p> 		<p>Make a space of at least 2mm, 0.08" in front of the area surrounded by 3 sides (relative to the feeding direction).</p>  <p>1, 2 = 2mm, 0.08"</p>
<p>Non-closed line</p> 		<p>Designate the area with a closed line.</p> 

Diagonal line method

Note

- A diagonal line must be drawn through the area that you wish to edit.

1 Put the command sheet on top of the original.

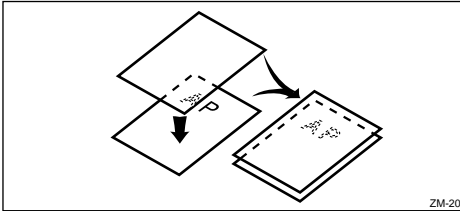

2 Draw a line using a felt tip pen (black, red or blue) with a thickness of at least 1mm.

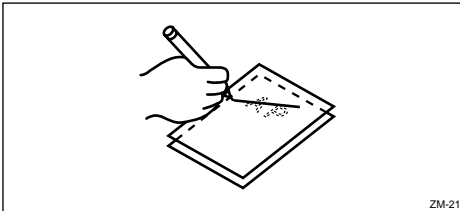

Note

- Make sure there is no break in the line.
- The diagonal line can be drawn from left to right or vice versa.
- Draw the line at least 2mm, 0.08", away from the image so that the complete image can be recognized.

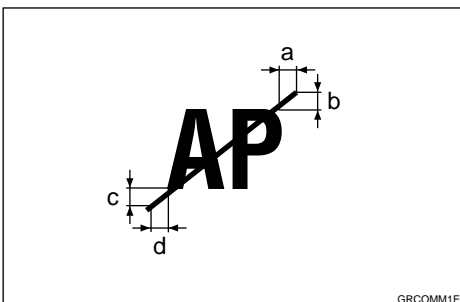

$a, b, c, d = 2\text{mm}, 0.08''$

- The line marking the designated area should be more than 2mm, 0.08", from any neighboring image.

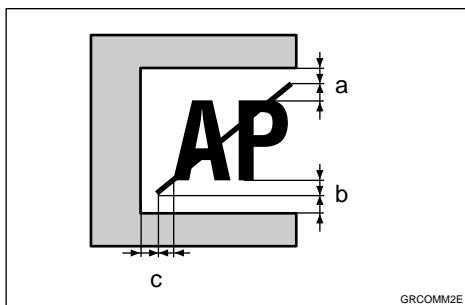

$a, b, c = 2\text{mm}, 0.08''$

Closed area method

 **Note**

- The line designating the area must be a closed loop.

1 Put the command sheet on top of the original.

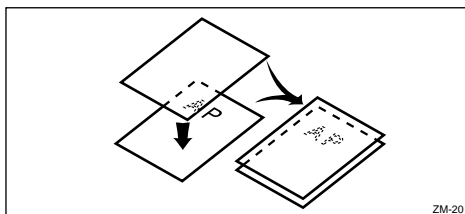

2 Using a black, red, or blue felt tip pen, draw a line around the area to designate. The line should have a thickness of at least 1mm.

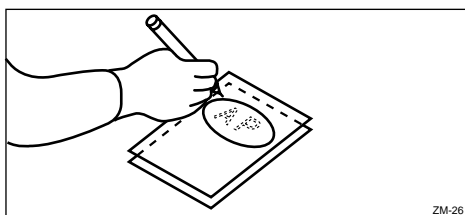

 **Note**

- Make sure there is no break in the line.
- Draw the line at least 2mm, 0.08", away from the image so that the complete image can be recognized.

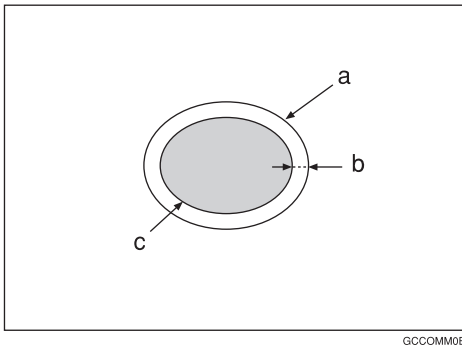

a = Line marking the designated area

b = 2mm, 0.08"

c = Image within the designated area

☐ The line marking the designated area should be more than 2mm, 0.08", from any neighboring image.

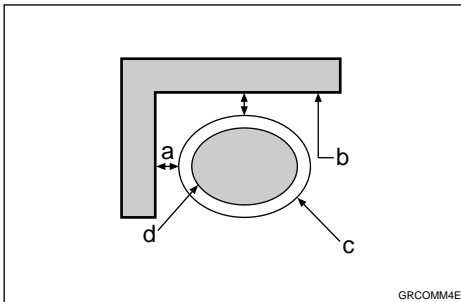

a = 2mm, 0.08"

b = Neighboring image

c = Line marking the designated area

d = image within the designated area

Command Sheets and Finished Prints

The following illustrations will help you understand how to draw a command sheet.

❖ Drawing a command sheet using a diagonal line

2

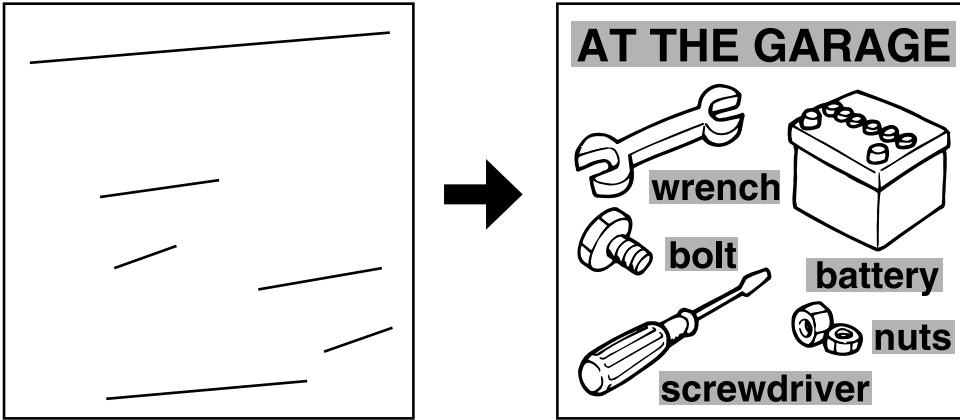

The diagonal line method is easy to use for designating rectangular areas. It is also more precise, but it is difficult to use for designating complex areas.

❖ Drawing a command sheet using a closed line

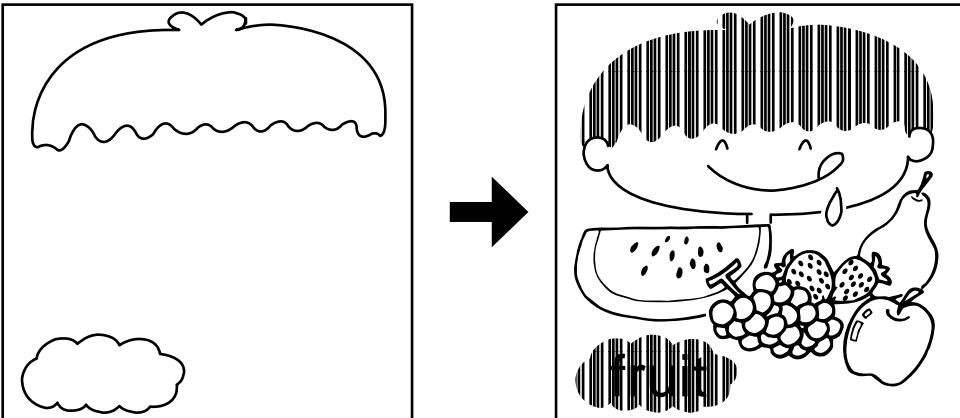

The closed line method is easier to use for complex areas, but it is less precise. It also takes longer to draw a command sheet with the closed line method.

Make-up Printing

1 Press the **[Make-Up]** key.

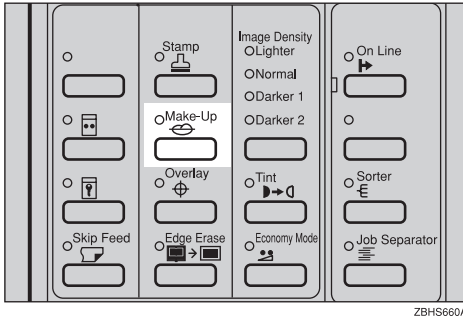

ZBHS660A

2 Make sure that **[1]** is selected. Then press the **[OK]** key.

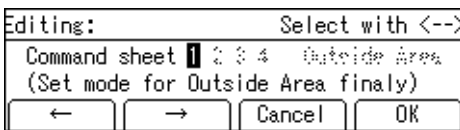

TPES506E

3 Select the frame shape with the **[←]** **[→]** or **[◀]** **[▶]** keys.

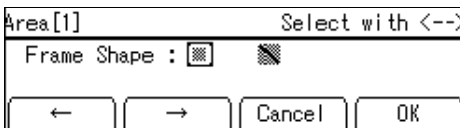

TPES506E

4 Press the **[OK]** key.

5 Select the mode for the first command sheet with the **[←]** **[→]** or **[◀]** **[▶]** **[▲]** **[▼]** keys.

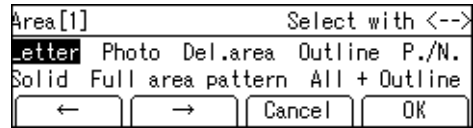

TPES530E

6 Press the **[OK]** key.

7 If necessary, select the pattern for the first command sheet with the **[◀]**, **[▶]**, **[▲]**, or **[▼]** key. Then press the **[OK]** key.

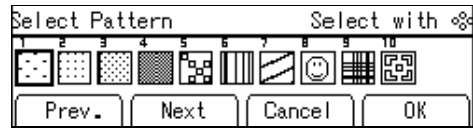

8 If necessary, select the size and direction of the pattern you selected in step **7** with the **[←]** **[→]** or **[◀]** **[▶]** keys.

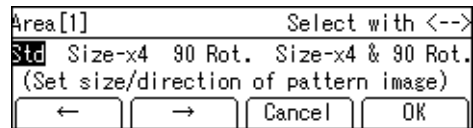

TPES530E

9 Press the **[OK]** key.

Note

- Follow steps **2** – **9** for the other command sheets.
- You can select a pattern registered with the user tools for only one command sheet.

- To change the value entered, press the **[Clear/Stop]** key and enter the new value.

10 After you have finished designating modes for all the command sheets, select **[Outside Area]** with the **[←]** **[→]** or **[◀]** **[▶]** keys.

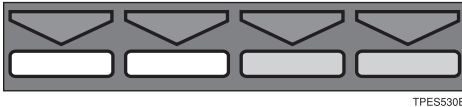
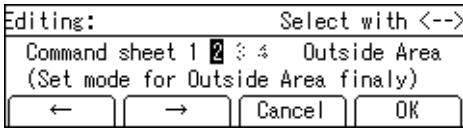

TPES530E

11 Select the mode for the outside area with the **[←]** **[→]** or **[◀]** **[▶]** keys.

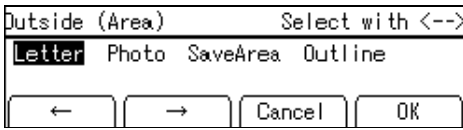

TPES530E

12 Press the **[OK]** key.

Note

- When you select Photo mode for both inside and outside areas, you cannot select different coarseness and image density.
- When you want to confirm your settings, press the **[Make-Up]** key twice. Then press the **[OK]** key repeatedly until the panel display reaches the setting you want to confirm.

13 If you have selected Photo mode, select the coarseness and the image density with the **[←]** **[→]** or **[◀]** **[▶]** keys.

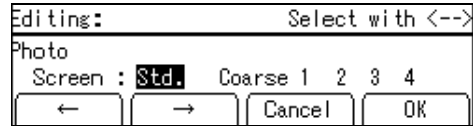

TPES530E

Note

- Four coarseness settings are available:
 - Setting 4: coarsest
 - Setting 3: coarser than setting 2
 - Setting 2: coarser than setting 1
 - Setting 1: coarser than the standard setting

14 Press the **[OK]** key.

15 Set the first command sheet face down on the exposure glass (contact glass) and press the **[Start]** key.

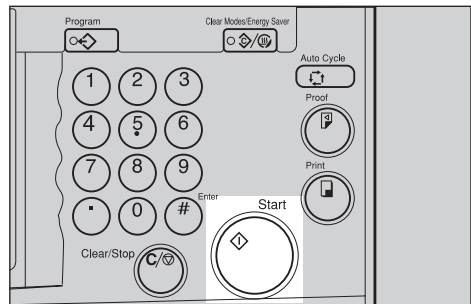

ZBHS280N

The beeper sounds after the command sheet is scanned.

Note

- Repeat step **15** for the other command sheets.

16 Set the original face down on the exposure glass (contact glass) and press the **[Start]** key.

Make-up Printing with the Optional Document Feeder

Under the following conditions, you should set command sheets and the original on the exposure glass (contact glass):

- When using paste-up originals.
- When the command sheets and original are of different size.

With the optional document feeder, you can designate areas to be edited in Make-up mode within the following limits:

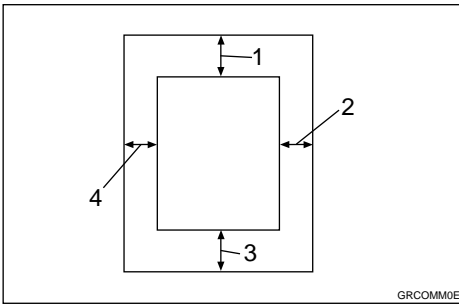

1 = 3mm, 0.12"

2 = 3mm, 0.12"

3 = 3mm, 0.12"

4 = 3mm, 0.12"

Note

- When using coated paper or transparent paper as a command sheet, set the command sheet and original separately into the document feeder.

1 Press the **[Make-Up]** key.

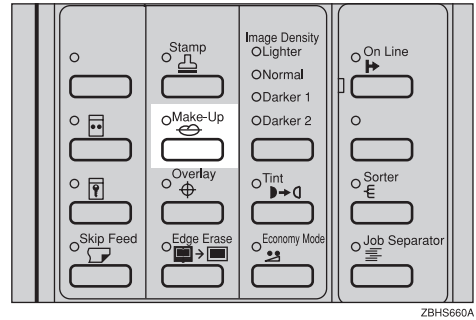

2

2 Make sure that **[1]** is selected. Then press the **[OK]** key.

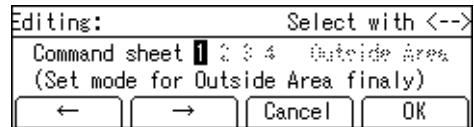

3 Select the frame shape with the **[←]** **[→]** or **[<]** **[>]** keys.

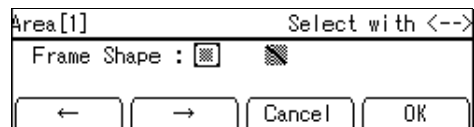

4 Press the **[OK]** key.

5 Select the mode for the first command sheet with the [←] [→] or [◀] [▶] [△] [▽] keys.

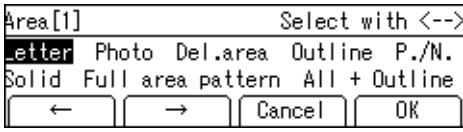

TPES530E

6 Press the [OK] key.

7 If necessary, select the pattern for the first command sheet with the [◀], [▶], [△], or [▽] key. Then press the [OK] key.

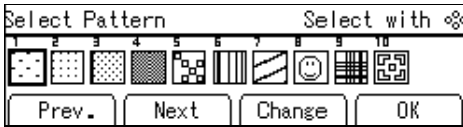

8 If necessary, select the size and direction of the pattern you selected in step 7 with the [←] [→] or [◀] [▶] keys.

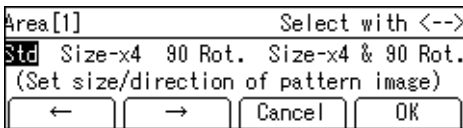

TPES530E

9 Press the [OK] key.

Note

- Follow steps 2 – 9 for the other command sheets.
- You can select a pattern registered with the user tools for only one command sheet.
- To change the value entered, press the [Clear/Stop] key and enter the new value.

10 After you have finished designating modes for all the command sheets, select [Outside Area] with [←] [→] or [◀] [▶] keys. Then press the [OK] key.

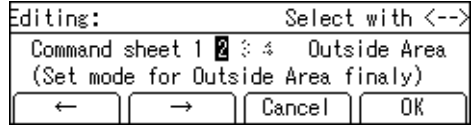

TPES530E

11 Select the mode for the outside area with the [←] [→] or [◀] [▶] keys.



TPES530E

12 Press the [OK] key.

Note

- When you select Photo mode for both inside and outside areas, you cannot select different coarseness and image density.
- When you want to confirm your settings, press the [Make-Up] key twice. Then press the [OK] key repeatedly until the panel display reaches the setting you want to confirm.

- 13** When you select Photo mode, select the coarseness and image density with the [←] [→] or [◀] [▶] keys.

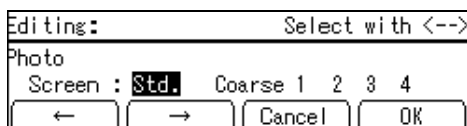

TPES530E

 **Note**

- Four coarseness settings are available:
 - Setting 4: coarsest
 - Setting 3: coarser than setting 2
 - Setting 2: coarser than setting 1
 - Setting 1: coarser than the standard setting

- 14** Press the [OK] key.

- 15** Set the command sheets and original face up into the document feeder.

 **Note**

- Make sure that the command sheets are set on the original.

- 16** Press the [Start] key.

 **Note**

- If a command sheet or an original misfeeds, remove the misfed sheets or original and reset it into the document feeder. It is not necessary to reset the previous command sheets or original.

Make-up Samples

Sample 1

- ① Command Sheet No. 1, Frame shape \square , Designated area: Delete Area mode
- ② Outside area: Letter mode
- ③ Print

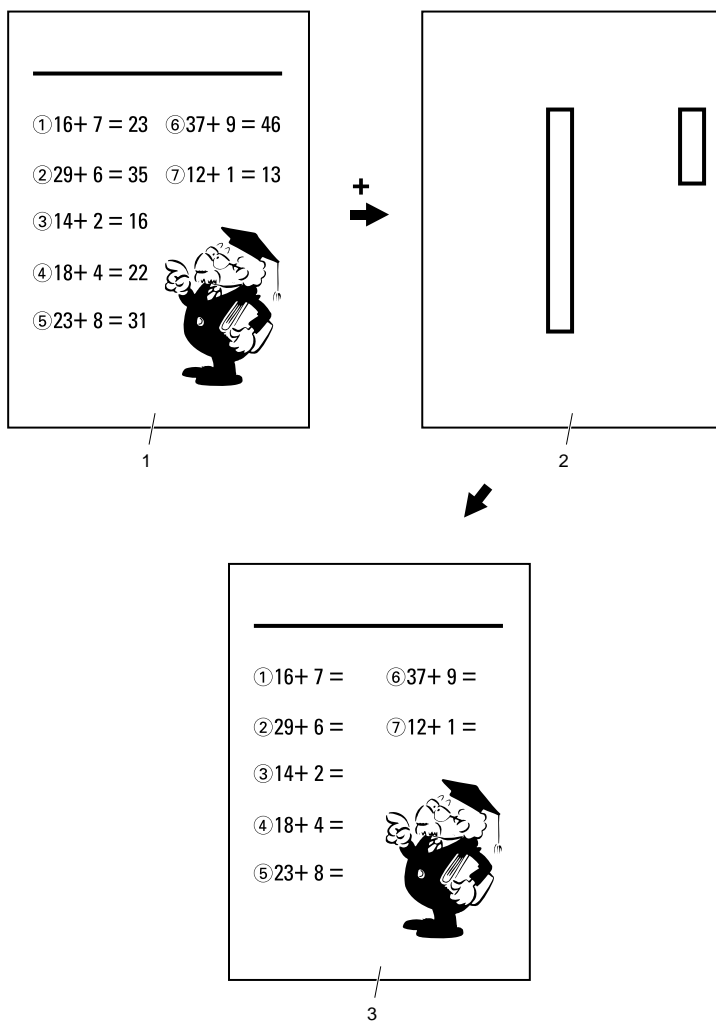

1. Original

3. Print

2. Command sheet No.1

ZM-50

Sample 2

- ① Command Sheet No. 1, Frame shape /, Designated area: All + Outline No. 30
- ② Command Sheet No. 2 Frame shape □, Designated area: All page pattern No. 17
- ③ Outside area: Fn1
- ④ Print

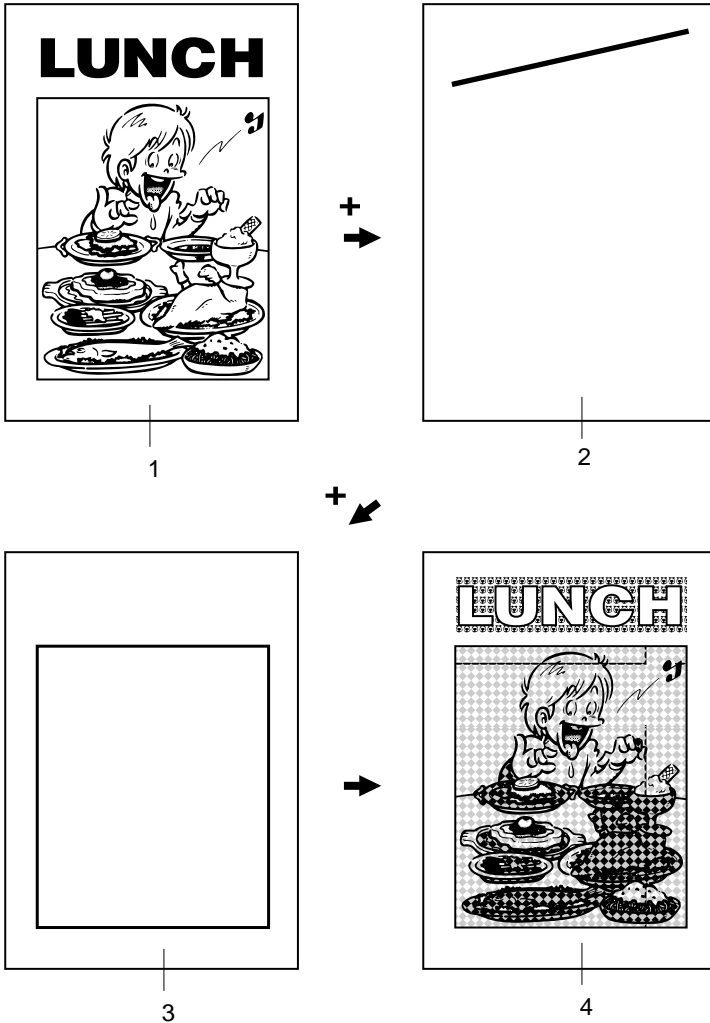

ZM-51

1. Original

2. Command sheet No.1

3. Command sheet No.2

4. Print

 **Sample 3**

- ① Print the original as it is
- ② Change the drum unit for colour printing
- ③ Command Sheet No. 1, Frame shape , Designated area: All page pattern No. 39
- ④ Outside area: Letter mode
- ⑤ Print

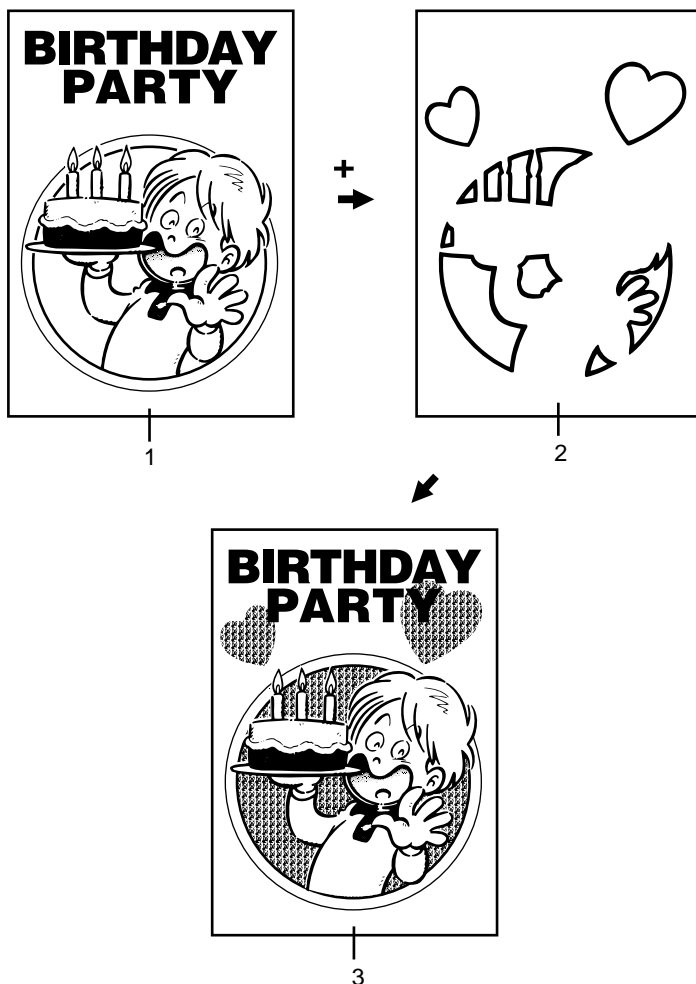

1. Original

3. Print

2. Command sheet No.1

Image Overlay—Merging Images

The machine can merge two different originals onto the same print paper.

Two types of merging are available:

❖ Overlay

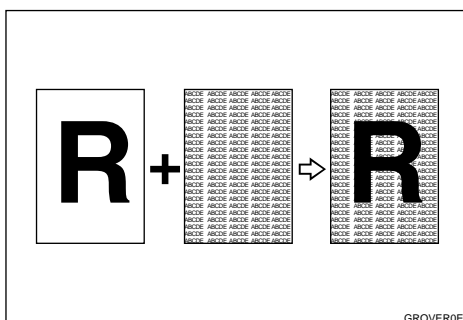

Two different originals are merged onto the same print paper.

❖ Form

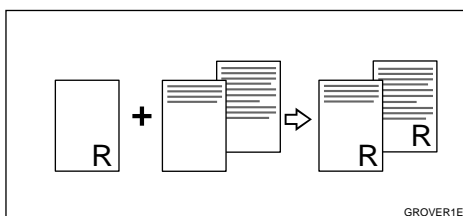

The image of the original which is copied first will become the background image for all copies. The following originals will be copied with this background.

❖ On Line overlay

An image sent from a PC and the original image can be merged onto the same print paper.

💡 Limitation

- ❑ The optional memory board is required to use Overlay or Form mode.
- ❑ The optional PC controller is required to use On Line Overlay mode.

- ❑ In order to get a correct print image, the sizes of the original and the PC image should be identical.

1 Press the [Overlay] key.

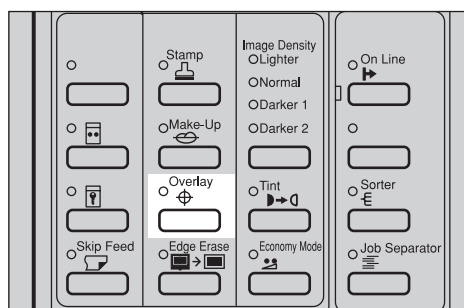

2 Select one of Image Overlay modes with the [←] [→] or [◀] [▶] keys.

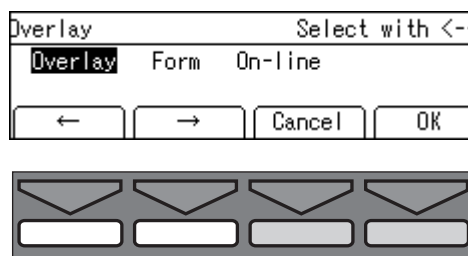

3 Press the [OK] key.

4 Set your originals and press the [Start] key.

Setting originals on the exposure glass (contact glass)

- 1 Set the first original on the exposure glass (contact glass).

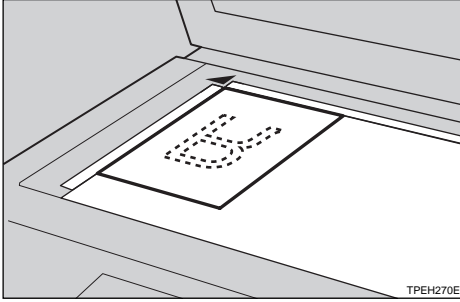

- 2 Press the **[Start]** key.

 **Note**

- When you select **[Form]** in step 2, the original for the template should be set first.
- To change the background image in Form mode, press the **[#]** key. Then set the next original for the template and press the **[Start]** key.

- 3 Set the next original on the exposure glass (contact glass).

- 4 Press the **[Start]** key.

 **Note**

- When you select **[Form]** in step 2, repeat steps 3 and 4.

Setting originals in the optional document feeder

- 1 Set originals in the document feeder.

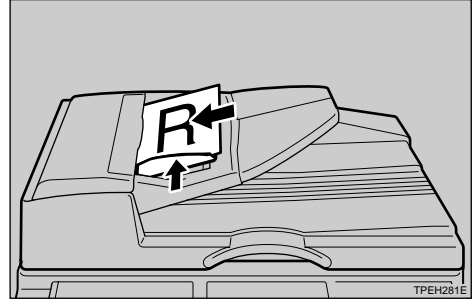

- 2 Press the **[Start]** key.

 **Note**

- When you select **[Form]** in step 2, the original for the template should be on the top.
- To change the background image in Form mode, press the **[#]** key. Then set the next original for the template and press the **[Start]** key.

Date Stamp—Having the Date Stamped on Prints

Use this function to have the date stamped on prints.

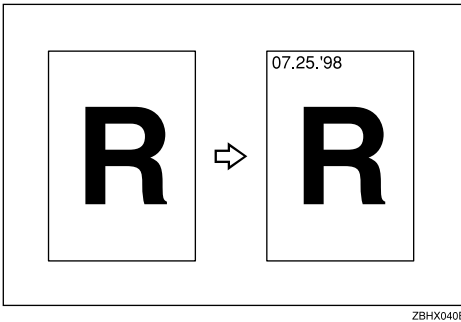

Preparation

Before you use this function, you have to set the machine's internal clock with the user tools. See ⇒ P.156 "1-8 Time Setting".

Limitation

- The optional memory board is required.
- The font size of the date cannot be changed.
- If you select Page Stamp and Date Stamp together, the last stamp direction selected takes priority.

Note

- The default format of Date Stamp is "Month Day Year". You can change this setting with the user tools. See "Date Style Set" ⇒ P.151 "5. Stamp".
- You can edit the Date Stamp position. See ⇒ P.166 "5-11 Position (Date)".
- The Date Stamp directions on the panel display and actual print images are as follows:

Date Stamp direction on the display	Print image		
	ZBHX050E	ZBHX060E	ZBHX070E
	ZBHX080E	ZBHX090E	ZBHX100E
	ZBHX110E	ZBHX120E	ZBHX130E
	ZBHX140E	ZBHX150E	ZBHX160E

1 Press the [Stamp] key.

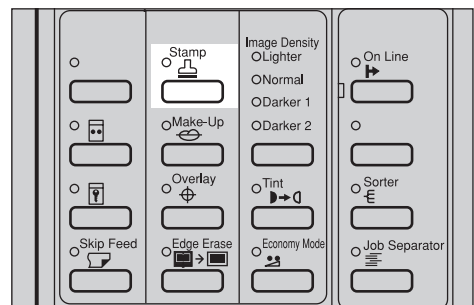

ZBHS700A

2 Make sure that [Date] is selected.

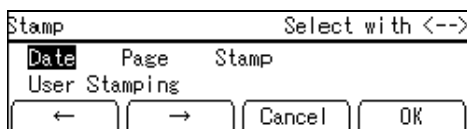

3 Press the [OK] key.

4 Select the desired position and direction with the [←] [→] or [◀] [▶] keys.

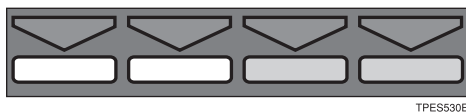
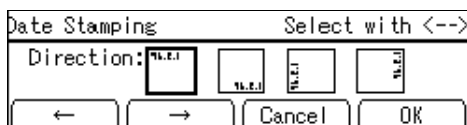

TPESS30E

5 Press the [OK] key.

6 Select the [Yes] or [No] key.

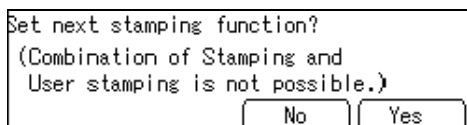

TPESS80E

Note

- Press the [Yes] key if you wish to set the other Stamp functions.

7 Set your original and press the [Start] key.

Setting your original (📄) on the exposure glass (contact glass)

1 Set your original as shown in the illustration.

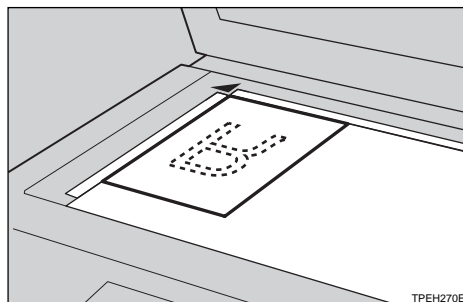

TPEH270E

Setting your originals (📄) in the optional document feeder

1 Set your originals as shown in the illustration.

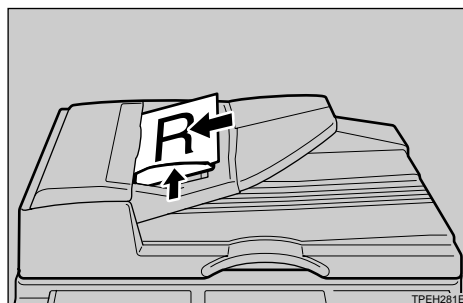

TPEH281E

Page Stamp—Having Page Numbers Stamped on Prints

Use this function to have page numbers stamped on prints.

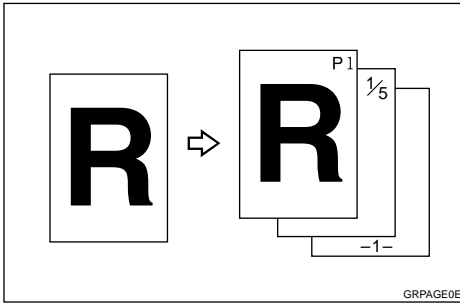

Three numbering formats are available:

- P1, P2,....., P5
- 1/5, 2/5,....., 5/5
- -1-, -2-,....., -3-

Limitation

- The optional memory board is required.
- The size and font of Page Stamp cannot be changed.
- If you select Page Stamp and Date Stamp together, the last stamp direction selected takes priority.

Note

- Check the following table for the relationship between the Page Stamp direction on the panel display and the actual print image:

Page Stamp direction on the display	Print image

- You can edit the preset page numbering position with the user tools. See ⇒ P.167 “5-14 Position (Page)”.
- [P1, P2,...., P5] is the default format. You can change this default setting with the user tools. See “Type(Page)” ⇒ P.151 “5. Stamp”.

1 Press the [Stamp] key.

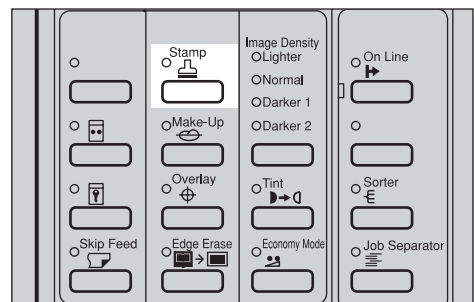

ZBHS700A

2 Select [Page] with the [→] or [▷] key.

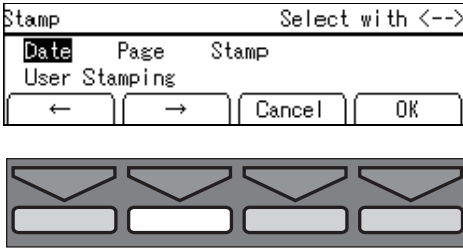

TPES570E

3 Press the [OK] key.

4 Select the desired format with the [←] [→] or [◀] [▶] keys.

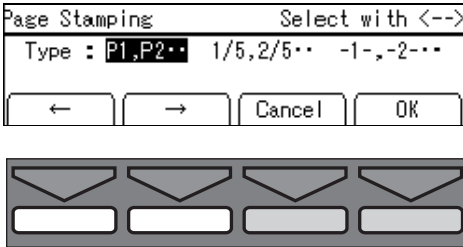

TPES530E

5 Press the [OK] key.

If you selected [P1,P2] or [-1,-2]

1 Enter the first page number with the [←] [→] or [◀] [▶] keys.

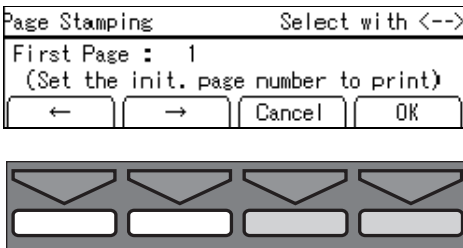

TPES530E

Note

- You can also enter the page number with the Number keys.
- To change the value entered, press the **[Clear/Stop]** key and enter the new value.

2 Press the [OK] key.

If you selected [1/5,2/5]

1 Enter the last page number with the [←] [→] or [◀] [▶] keys.

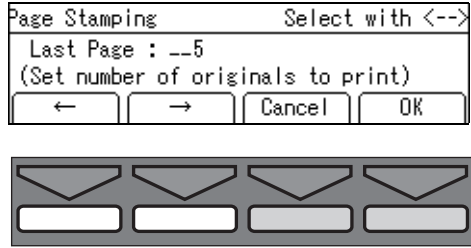

TPES530E

Note

- You can also enter the page number with the Number keys.
- To change the value entered, press the **[Clear/Stop]** key and enter the new value.

2 Press the [OK] key.

3 Enter the first page number with the [←] [→] or [◀] [▶] keys.

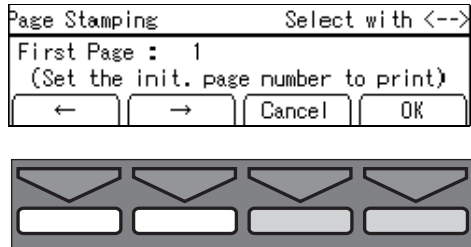

TPES530E

Note

- You can also enter the page number with the Number keys.
- To change the value entered, press the **[Clear/Stop]** key and enter the new value.

4 Press the [OK] key.

- 6** Select the desired orientation with the [←] [→] or [◀] [▶] keys.

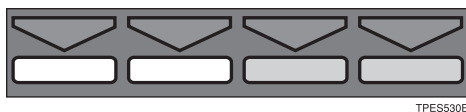
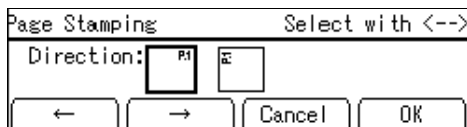

TPESS90E

- 7** Press the [OK] key.

- 8** Select the [Yes] or [No] key.

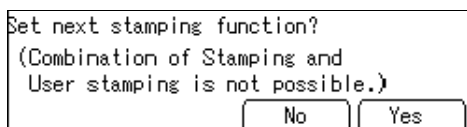

TPESS80E

Note

- Press the [Yes] key if you wish to set the other Stamp functions.

- 9** Set your original and press the [Start] key.

Setting your originals (📄) on the exposure glass (contact glass)

- 1** Set the first original as shown in the illustration.

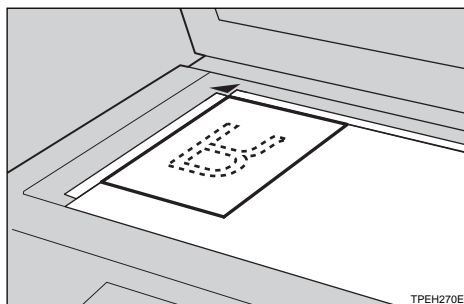

TPEH270E

Note

- Repeat step 9 for the other originals.

Setting your originals (📄) in the optional document feeder

- 1** Set your originals as shown in the illustration.

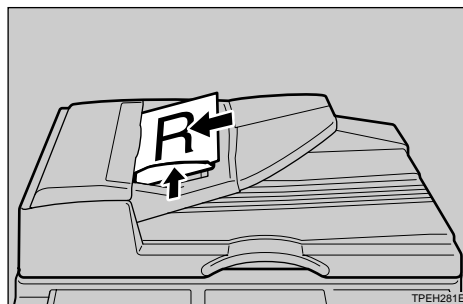

TPEH281E

Note

- The first original should be on the top.

Stamp—Having Preset Messages Stamped on Prints

2

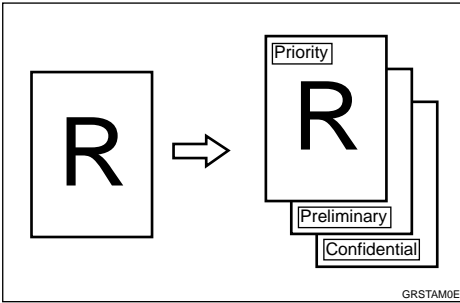

One of the following 3 messages can be stamped on prints.

- CONFIDENTIAL
- PRIORITY
- PRELIMINARY

Limitation

- The optional memory board is required.
- This function cannot be used with User Stamp.
- Only one message can be stamped at a time.

Note

- You can change some Stamp settings (size, density, or position) with the user tools. See "Size", "Stamp Density", "Stamp Position" ⇒ P.151 "5. Stamp".
- The message "CONFIDENTIAL" is selected as a default. You can change this setting with the user tools. See "Type" ⇒ P.151 "5. Stamp".

1 Press the [Stamp] key.

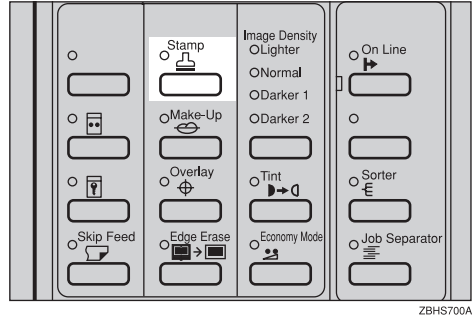

2 Select [Stamp] with the [←] [→] or [◀] [▶] keys.

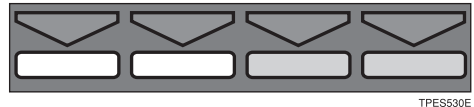
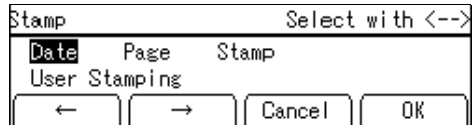

3 Press the [OK] key.

4 Select the desired message with the [←] [→] or [◀] [▶] keys.

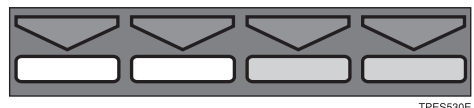
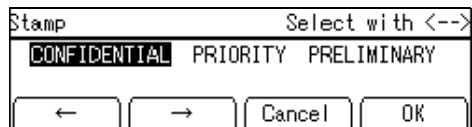

5 Press the [OK] key.

- 6** Select the page to be stamped with the [←] [→] or [◀] [▶] keys.

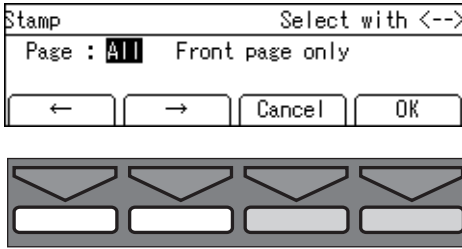

- 7** Press the [OK] key.

- 8** Select the stamp position with the [←] [→] or [◀] [▶] keys.

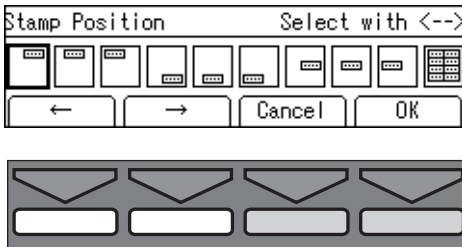

- 9** Press the [OK] key.

- 10** Select the [Yes] or [No] key.

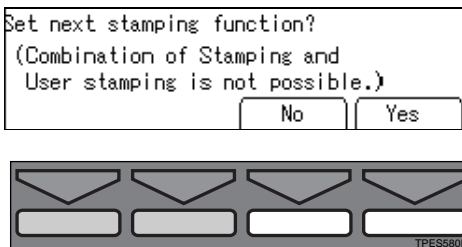

Note

- Press the [Yes] key if you wish to set the other Stamp functions.

- 11** Set your original and press the [Start] key.

Setting your original (☒) on the exposure glass (contact glass)

- 1** Set your original as shown in the illustration.

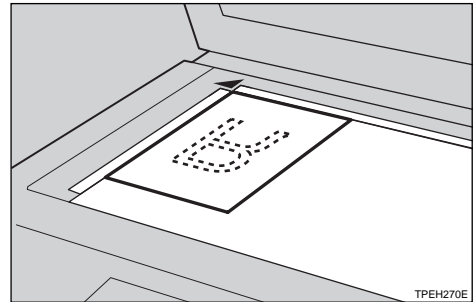

Setting your originals (☒) in the optional document feeder

- 1** Set your originals as shown in the illustration.

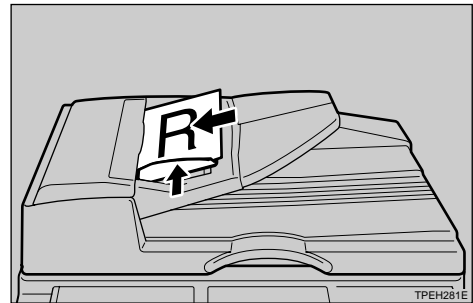

User Stamp—Having Custom Messages Stamped on Prints

Up to 4 messages which you use frequently can be stored in the machine memory. You can have these messages stamped on your prints.

2

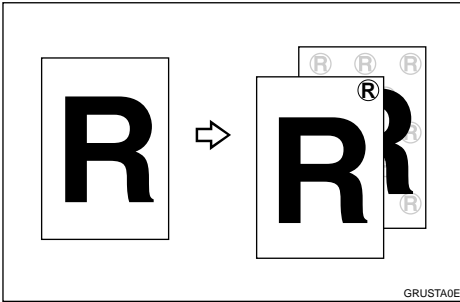

Preparation

You have to store your message with the user tools. See ⇒ P.165 "5-8 Regist. (User)".

Limitation

- The optional memory board is required.
- This function cannot be used with the Stamp function.
- Only one message can be stamped at a time.
- Registered stamps cannot be deleted. If you want to change a registered stamp, overwrite it.

Note

- You can change some User Stamp settings (size, density, or position) with the user tools. See "Size(User Stamp)", "Density (User)", "Position(User)" ⇒ P.151 "5. Stamp".

1 Press the [Stamp] key.

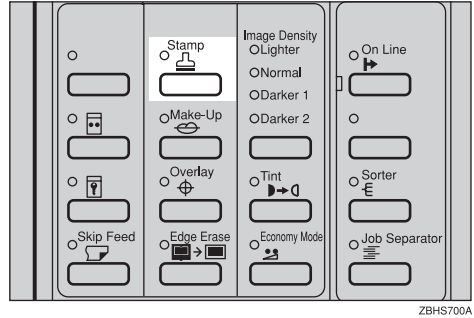

2 Select [User Stamping] with the [←] [→] or [◀] [▶] keys.

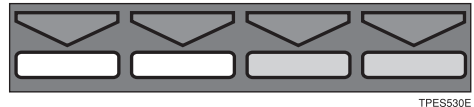
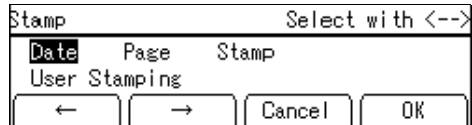

3 Press the [OK] key.

4 Select the desired stamp with the [←] [→] or [◀] [▶] keys.

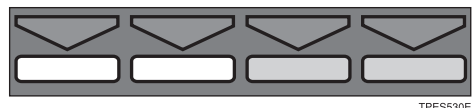
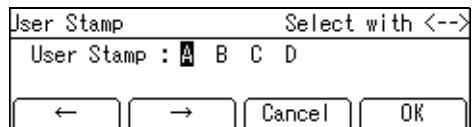

5 Press the [OK] key.

- 6 Select the page to be stamped with the [←] [→] or [◀] [▶] keys.

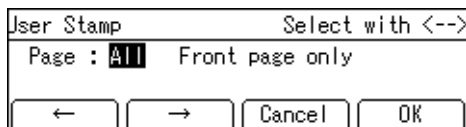

TPESS30E

- 7 Press the [OK] key.

- 8 Select the stamp position with the [←] [→] or [◀] [▶] keys.

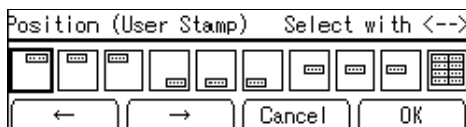

TPESS30E

- 9 Press the [OK] key.

- 10 Select the [Yes] or [No] key.

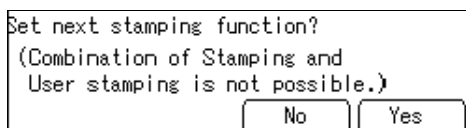

TPESS80E

Note

- Press the [Yes] key if you wish to set the other Stamp functions.

- 11 Set your original and press the [Start] key.

Setting your original () on the exposure glass (contact glass)

- 1 Set your original as shown in the illustration.

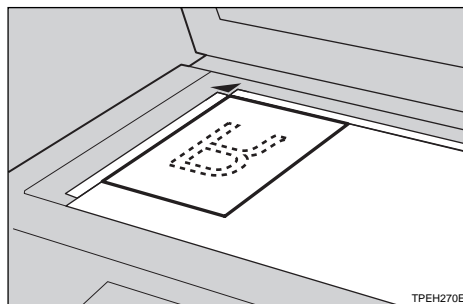

TPEH270E

2

Setting your originals () in the optional document feeder

- 1 Set your originals as shown in the illustration.

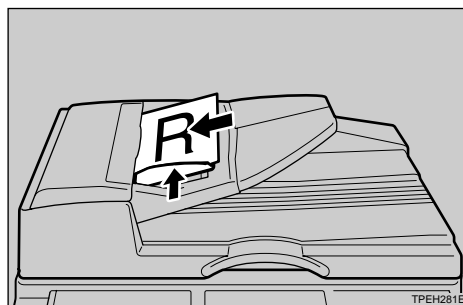

TPEH281E

Memory Combine—Combining Originals into one Print with the Memory Board

You can combine originals in four ways:

❖ **4 single-sided originals → 1 single-sided print of 4 images**

4 one-sided pages are printed onto 1 one-sided sheet, 4 original images on one side.

❖ **8 single-sided originals → 1 single-sided print of 8 images**

8 one-sided pages are printed onto 1 one-sided sheet, 8 original images on one side.

❖ **16 single-sided originals → 1 single-sided print of 16 images**

16 one-sided pages are printed onto 1 one-sided sheet, 16 original images on one side.

❖ **Repeating an image over the entire print**

1 original image is printed repeatedly.

🔔 **Limitation**

- The optional memory board is required.

📝 **Note**

- A separation line between images can be printed with the user tools. See “Comb. Sep. Line” ⇒ P.146 “4. Mode Setting”.

Combining Several Single-sided Originals onto one Single-sided Print

❖ **4 single-sided originals → 1 single-sided print of 4 images**

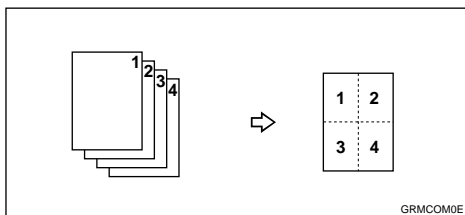

❖ 8 single-sided originals → 1 single-sided print of 8 images

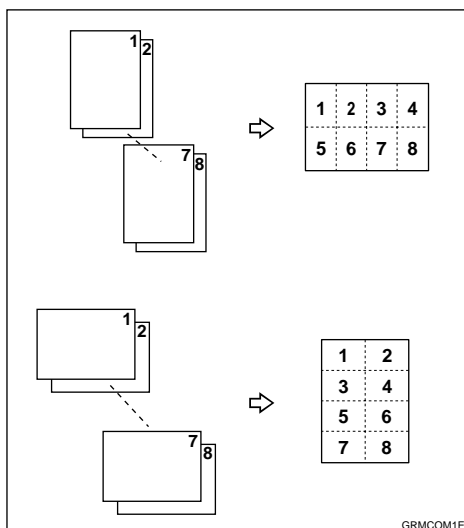

❖ 16 single-sided originals → 1 single-sided print of 16 images

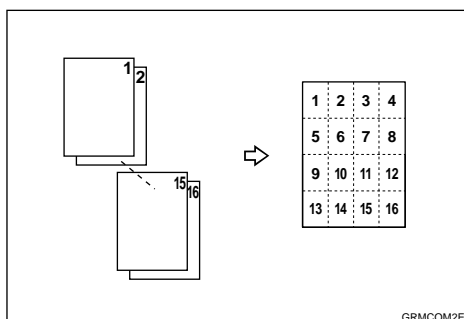

⚠ Limitation

- ❑ To use “16 one-sided originals → 1 one-sided print of 16 images” mode, the optional document feeder is required.
- ❑ If the calculated ratio is under the minimum ratio, it is corrected within the range of the ratio automatically. However, with some ratios, parts of the image might not be copied.
- ❑ The machine cannot copy originals different in size and direction.

📝 Note

- ❑ The number of originals printed (combined) can be 4, 8, or 16.
- ❑ In this mode, the machine selects the reproduction ratio automatically. This reproduction ratio depends on the print paper sizes and the number of originals.
- ❑ When the original is set at a different direction from the print paper, the machine automatically rotates the original image by 90° to match the print paper direction.

- ❑ You can set the machine to cancel Memory Combine mode after finishing your print job with the user tools. See “Cancel Comb.” ⇒ P.146 “4. Mode Setting”.
- ❑ Refer to the following table when you select the original and paper sizes.

❖ **Setting originals in the optional document feeder (metric version)**

Original	A3	B4	A4	B5	A5
Paper					
A3	*3	*3	*2	*2	*1
B4	--	*3	*3	*2	*2
A4	--	--	*3	*3	*2
B5	--	--	--	*3	*3

*1 You can use these original and paper sizes in Combine 4, 8, 16 Originals mode.

*2 You can use these original and paper sizes in Combine 4, 8 Originals mode.

*3 You can use these original and paper sizes in Combine 4 Originals mode.

❖ **Setting originals in the optional document feeder (inch version)**

Original	11" × 17"	8 ¹ / ₂ " × 14"	8 ¹ / ₂ " × 11"	8 ¹ / ₂ " × 5 ¹ / ₂ "
Paper				
11" × 17"	*3	*3	*2	*1
8 ¹ / ₂ " × 14"	--	*3	*3	*2
8 ¹ / ₂ " × 11"	--	--	*3	*2
5 ¹ / ₂ " × 8 ¹ / ₂ "	--	--	--	*3

*1 You can use these original and paper sizes in Combine 4, 8, 16 Originals mode.

*2 You can use these original and paper sizes in Combine 4, 8 Originals mode.

*3 You can use these original and paper sizes in Combine 4 Originals mode.









❖ **Setting originals on the exposure glass (metric version)**

Original	A3	B4	A4	B5
Paper				
A3	*2	*2	*1	*1
B4	--	*2	*2	*1
A4	--	--	*2	*2
B5	--	--	--	*2

*1 You can use these original and paper sizes in Combine 4, 8 Originals mode.

*2 You can use these original and paper sizes in Combine 4 Originals mode.

❖ **Setting originals on the exposure glass (inch version)**

Original	11" × 17" 	8 1/2" × 14" 	8 1/2" × 11"  
Paper			
11" × 17" 	*2	*2	*1
8 1/2" × 14" 	--	*2	*2
8 1/2" × 11"  	--	--	*2
5 1/2" × 8 1/2" 	--	--	--

*1 You can use these original and paper sizes in Combine 4, 8 Originals mode.

*2 You can use these original and paper sizes in Combine 4 Originals mode.

1 Press the **[Combine]** key.

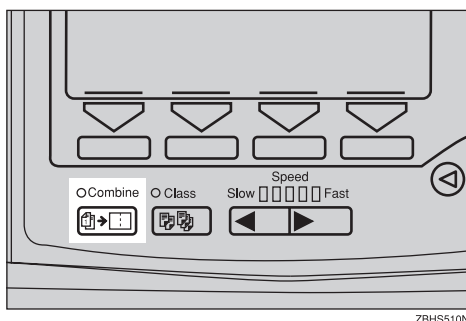

2 Select **[Memory Combine]** with the **[←]** or **[↶]** key.

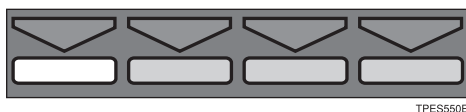
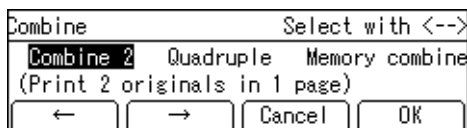

3 Press the **[OK]** key.

4 Select your desired mode.

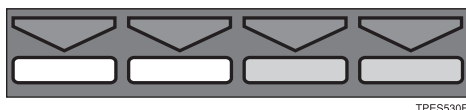
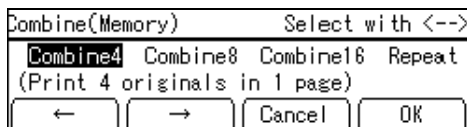

5 Press the [OK] key.

6 Set your originals.

Setting your original (☐) on the exposure glass (contact glass)

1 Set your original as shown in the illustration.

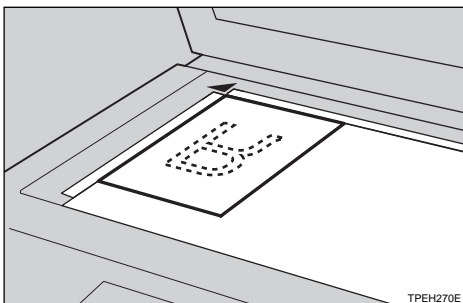

Setting your originals (☐) in the optional document feeder

1 Set your originals as shown in the illustration.

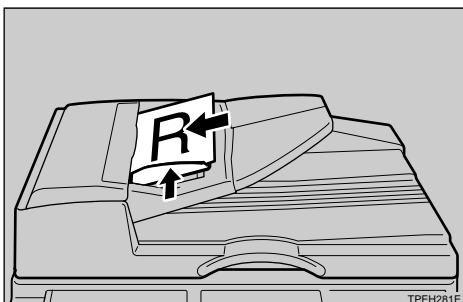

Note

- The first original should be on the top.

7 Press the [Start] key.

Note

- Even if the number of originals is less than the number required in the selected mode, prints can be made as shown in the illustration. In this case, press the [#] key after all the originals have been scanned.

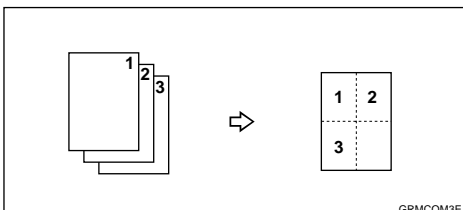

- ❑ When setting an original on the exposure glass (contact glass) or one sheet at a time in the optional document feeder, repeat steps 6 and 7. After setting the last original, press the [#] key then the [Start] key.

Repeat—Repeating an Image over the Entire Print

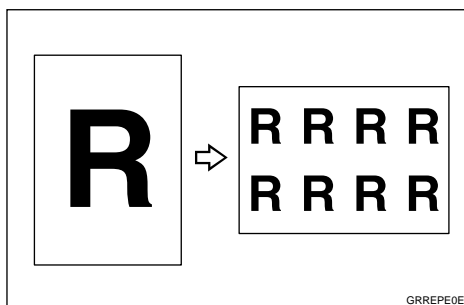

Limitation

- ❑ Part of the repeated image might not be printed depending on the paper size, direction and reproduction ratio.

Note

- ❑ The number of repeated images depends on the original and paper size, and reproduction ratio.
- ❑ Check the following table for the relationship between the direction of the original and paper, and the number of repeated images:

❖ E.g. copying A4 originals onto A3 paper.

The number of repeated images	Reproduction ratio	Print image
4	71%	

2

❖ E.g. copying A5 originals set in the optional document feeder onto A3 paper.

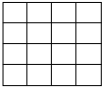
Number of repeated images	Reproduction ratio	Print image
16	50%	 <small>GRREPE4E</small>

❖ E.g. copying 8 1/2" x 11" originals onto 11" x 17" paper.

Number of repeated images	Reproduction ratio	Print image
2	100%	 <small>GRREPE5E</small>

❖ E.g. copying A5 originals set in the optional document feeder onto A4 paper.

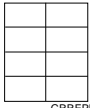
Number of repeated images	Reproduction ratio	Print image
8	50%	 <small>GRREPE6E</small>

1 Press the [Combine] key.

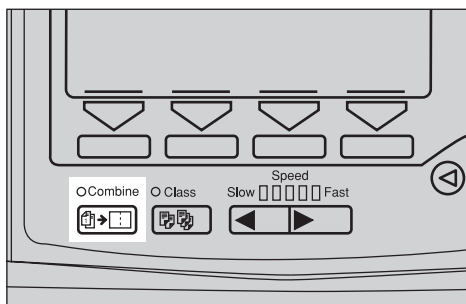

ZBHS510N

- 2** Select [Memory Combine] with the [←] or [↵] key.

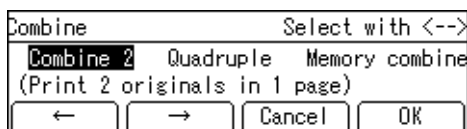

TPES550E

- 3** Press the [OK] key.

- 4** Select [Repeat] with the [←] or [↵] key.

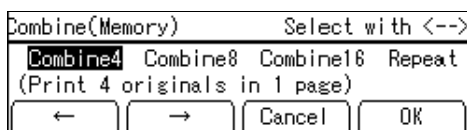

TPES550E

- 5** Press the [OK] key.

- 6** Select the reproduction ratio.

 **Reference**

See ⇒ P.29 “Preset Reduce/Enlarge—Reducing and Enlarging Using Preset Ratios”.

- 7** Set your original.

Setting your original (□) on the exposure glass (contact glass)

- 1** Set your original as shown in the illustration.

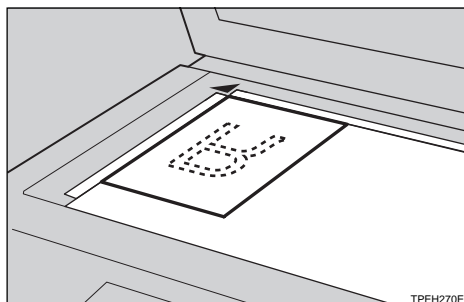

TPEH270E

Setting your originals (☐) in the optional document feeder

- 1 Set your originals as shown in the illustration.

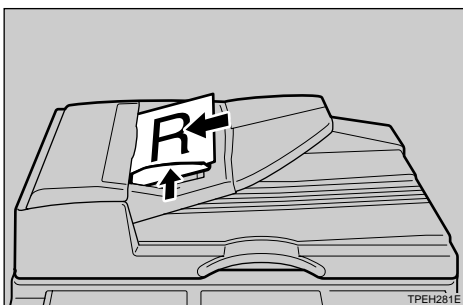









- 2 Press the **[Start]** key.

Sort/Class Sort

Use this function to have the machine scan your originals and automatically sort the prints.

Note

- The optional sorter is required.
- The paper sizes that can be used with the Sort and Class Sort functions are as follows:

Metric version	A3  , B4  , A4   , B5 
Inch version	11" × 17"  , 8 1/2" × 14"  , 8 1/2" × 11"  

- The maximum bin capacity is as follows:
 - 50 sheets (52 - 80g/m², 13.9 - 21.2 lb)
 - 40 sheets (81 - 105g/m², 21.5 - 27.8 lb)
- If the prints have many images, the bin capacity might be reduced.
- When the number of prints exceeds the bin capacity, the machine does the following:

Number of Sets	Operation
1 - 20 sets	Prints continue to be delivered to the 21st bin.
21 - 40 sets	Printing stops. Printing restarts when you remove all prints from the bins and press the [Print] key.

- When you make prints of less than 20 sets (first job) with the Sort/Class Sort function, the prints are delivered to the lower tray bin. If you make prints (less than 20 sets) of another original with the Sort/Class Sort function (second job) without removing the previously made prints from the bin, the prints of the second job will be delivered to the upper tray bin of the sorter.

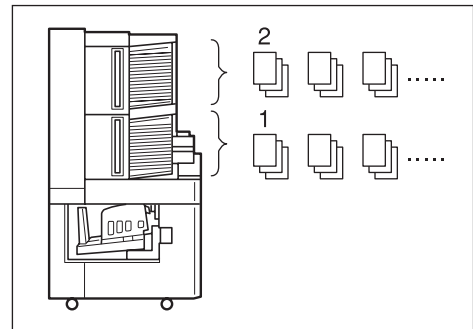

ZADP140E

1: First Job

2: Second Job

- When you remove prints from the bins, be careful not to rub the printed side against the bin. Otherwise, the printed side might be marked with ink. This is likely to occur especially when printing documents with many images or solid areas. As an easy solution, place a blank sheet of paper on top of the stack of originals before you make the master and prints.

- ❑ If you cannot remove prints from the sorter bins, you can widen the gap between bins by pressing the green button. If you hold down the button, the bins ripple open.

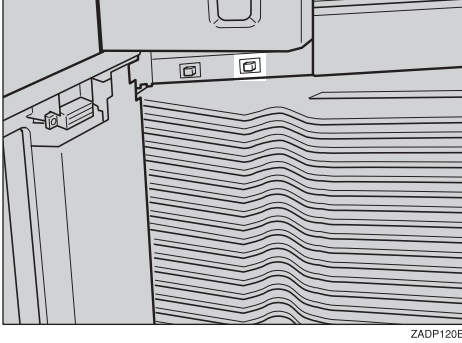

- ❑ When the optional document feeder is installed and the Sortfunction or Class Sort function is activated with the Auto Cycle function, the machine can make the master and prints in one operation. See ⇒ P.49 "Auto Cycle—Making Master and Prints in one Operation".

Sort—Sorting into Sets (123, 123, 123)

Use this function to have print sets sorted in sequential order.

Note

- ❑ When the number of prints exceeds 40 sets, the prints are delivered to the paper delivery tray with the Job Separation function.

Number of sets	Where prints are delivered
1 - 40 sets	Sorter
41 sets -	Paper Delivery Tray (Job Separation function)

1 Press the [Sorter] key.

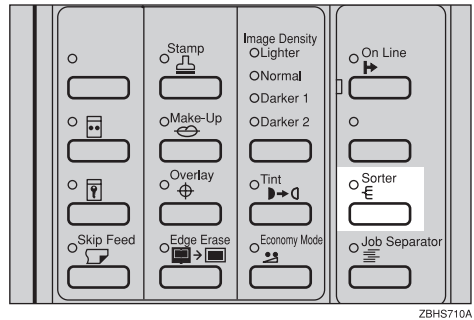

2 Make sure that [Sort] is selected.

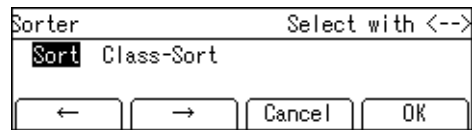

3 Enter the number of prints using the Number keys.

4 Set the originals.

5 Press the [Start] key.

6 Press the [Print] key.

Note

- ❑ A trial print is delivered to the paper delivery tray.
- ❑ The prints are delivered to the bin at the bottom of the sorter.

- When you place the originals in the optional document feeder, the machine automatically keeps making their masters without you having to press the **[Start]** key after page 2. Repeat step 6 for the all originals.

Class Sort

Use this function when copying a single-page original to have the same number of prints stacked in each bin.

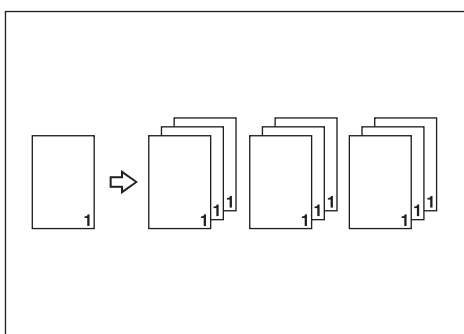

GCCLSR0E

Note

- The maximum number of sets that you can enter for the Class Sort-function is 38.
- If prints remain in the sorter, the maximum number of sets that you can enter is 18.

1 Press the **[Sorter]** key.

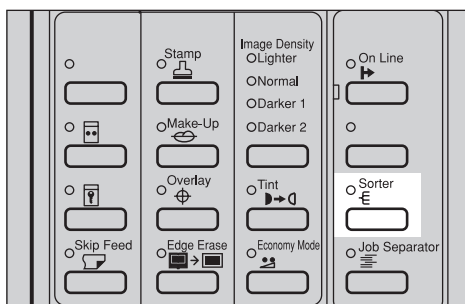

ZBHS710A

2 Select **[Class Sort]** with the **[→]** or **[▷]** key.



TPES570E

3 Press the **[OK]** key.

4 With the Number keys, enter the desired number of prints for each set. Then press the **[#]** key.

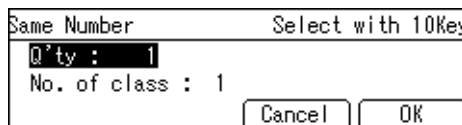

5 With the Number keys, enter the desired number of sets. Then press the **[#]** key.

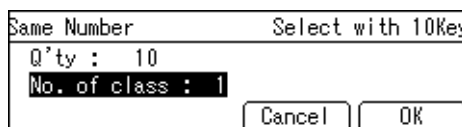

6 Press the **[OK]** key.

7 Set your originals.

8 Press the **[Start]** key. Then press the **[Print]** key.

Note

- If you wish to make prints of another original with the Class Sortfunction, repeat the procedure after step 7.
- The prints are delivered to the bin at the bottom of the sorter.

3. Combination Chart

Combination Chart

This combination chart shows which modes can be used together.

☆	means that these modes can be used together.
X	means that these modes cannot be used together.
*1	means that these modes cannot be used together (the function chosen second takes priority)
*2	means that these modes cannot be used together (the function chosen first takes priority)

		Function chosen second																																	
		Letter, Photo, Letter/Photo, Pencilmode	Economy mode	Tint mode	Auto Cycle	Preset Reduce/Enlarge	Zoom	Auto Magnification Selection	Directional Magnification (%)	Directional Magnification (size)	Combine Originals (2 Images on one sheet)	Combine Originals (4 Images on one sheet)	Memory Combine mode (4 Originals)	Memory Combine mode (8 Originals)	Memory Combine mode (16 Originals)	Edge Erase	All Class mode	Auto Class mode	Manual Class mode	Class mode	Job Separation	Overlay	Form	Date Stamp	Page Stamp	Stamp	User Stamp	Repeat	Make-up	Skip Feed	Sort	Class Sort	On Line		
Function specified earlier	Letter, Photo, Letter/Photo, Pencilmode	-	☆	*1	☆	☆	☆	☆	☆	☆	☆	☆	☆	☆	☆	☆	☆	☆	☆	☆	☆	☆	☆	☆	☆	☆	☆	☆	☆	☆	☆	☆	☆	☆	☆
	Economy mode	☆	-	☆	☆	☆	☆	☆	☆	☆	☆	☆	☆	☆	☆	☆	☆	☆	☆	☆	☆	☆	☆	☆	☆	☆	☆	☆	☆	☆	☆	☆	☆	☆	☆
	Tint mode	*1	☆	-	☆	☆	☆	☆	☆	☆	☆	☆	☆	☆	☆	☆	☆	☆	☆	☆	☆	☆	☆	☆	☆	☆	☆	☆	☆	☆	☆	☆	☆	☆	☆
	Auto Cycle	☆	☆	☆	-	☆	☆	☆	☆	☆	☆	☆	☆	☆	☆	☆	☆	☆	☆	☆	☆	☆	☆	☆	☆	☆	☆	☆	☆	☆	☆	☆	☆	☆	☆
	Preset Reduce/Enlarge	☆	☆	☆	☆	-	☆	*1	*1	*1	☆	☆	☆	☆	☆	☆	☆	☆	☆	☆	☆	☆	☆	☆	☆	☆	☆	☆	☆	☆	☆	☆	☆	☆	*1
	Zoom	☆	☆	☆	☆	☆	-	*1	*1	*1	☆	☆	☆	☆	☆	☆	☆	☆	☆	☆	☆	☆	☆	☆	☆	☆	☆	☆	☆	☆	☆	☆	☆	☆	*1
	Auto Magnification Selection	☆	☆	☆	☆	*1	*1	-	*1	*1	☆	☆	☆	☆	☆	☆	☆	☆	☆	☆	☆	☆	☆	☆	☆	☆	☆	*1	☆	☆	☆	☆	☆	☆	*1
	Directional Magnification (%)	☆	☆	☆	☆	*1	*1	*1	-	*1	☆	☆	☆	☆	☆	☆	☆	☆	☆	☆	☆	☆	☆	☆	☆	☆	☆	☆	☆	☆	☆	☆	☆	☆	*1
	Directional Magnification (size)	☆	☆	☆	☆	*1	*1	*1	☆	-	☆	☆	☆	☆	☆	☆	☆	☆	☆	☆	☆	☆	☆	☆	☆	☆	☆	☆	☆	☆	☆	☆	☆	☆	*1
	Combine Originals (2 Images on one sheet)	☆	☆	☆	☆	☆	☆	☆	☆	☆	-	*1	*1	*1	*1	☆	☆	☆	☆	☆	☆	☆	*2	*2	*2	*2	*2	*2	*1	☆	☆	☆	☆	☆	*1

		Function chosen second																																
		Letter, Photo, Letter/Photo, Pencilmode	Economy mode	Tint mode	Auto Cycle	Preset Reduce/Enlarge	Zoom	Auto Magnification Selection	Directional Magnification (%)	Directional Magnification (size)	Combine Originals (2 Images on one sheet)	Combine Originals (4 Images on one sheet)	Memory Combine mode (4 Originals)	Memory Combine mode (8 Originals)	Memory Combine mode (16 Originals)	Edge Erase	All Class mode	Auto Class mode	Manual Class mode	Class mode	Job Separation	Overlay	Form	Date Stamp	Page Stamp	Stamp	User Stamp	Repeat	Make-up	Skip Feed	Sort	Class Sort	On Line	
Function specified earlier	Combine Originals (4 Images on one sheet)	☆	☆	☆	☆	☆	☆	☆	☆	☆	*1	-	*1	*1	☆	☆	☆	☆	☆	☆	☆	*2	*2	*2	*2	*2	*2	*1	☆	☆	☆	☆	*1	
	Memory Combinemode (4 Originals)	☆	☆	☆	☆	☆	☆	☆	☆	☆	*1	*1	-	*1	*1	☆	☆	☆	☆	☆	☆	*2	*2	*2	*2	*2	*2	*1	*2	☆	☆	☆	*1	
	Memory Combinemode (8 Originals)	☆	☆	☆	☆	☆	☆	☆	☆	☆	*1	*1	*1	-	*1	☆	☆	☆	☆	☆	☆	*2	*2	*2	*2	*2	*2	*1	*2	☆	☆	☆	*1	
	Memory Combinemode (16 Originals)	☆	☆	☆	☆	☆	☆	☆	☆	☆	*1	*1	*1	*1	-	☆	☆	☆	☆	☆	☆	*2	*2	*2	*2	*2	*2	*1	*2	☆	☆	☆	*1	
	Edge Erase	☆	☆	☆	☆	☆	☆	☆	☆	☆	☆	☆	☆	☆	☆	-	☆	☆	☆	☆	☆	☆	☆	☆	☆	☆	☆	☆	☆	☆	☆	☆	*1	
	All Class mode	☆	☆	☆	☆	☆	☆	☆	☆	☆	☆	☆	☆	☆	☆	☆	-	*1	*1	*1	*1	☆	☆	☆	☆	☆	☆	☆	☆	☆	*2	*2	*1	
	Manual Classmode	☆	☆	☆	☆	☆	☆	☆	☆	☆	☆	☆	☆	☆	☆	☆	☆	*1	*1	-	*1	☆	☆	☆	☆	☆	☆	☆	☆	☆	*2	*2	*1	
	Class mode	☆	☆	☆	☆	☆	☆	☆	☆	☆	☆	☆	☆	☆	☆	☆	☆	*1	*1	*1	-	☆	☆	☆	☆	☆	☆	☆	☆	☆	☆	*2	*2	*1
	Job Separation	☆	☆	☆	☆	☆	☆	☆	☆	☆	☆	☆	☆	☆	☆	☆	☆	☆	☆	☆	☆	☆	-	☆	☆	☆	☆	☆	☆	☆	☆	X	X	☆
	Overlay	☆	☆	☆	☆	☆	☆	☆	☆	☆	*2	*2	*2	*2	*2	☆	☆	☆	☆	☆	☆	☆	-	*1	*2	*2	*2	*2	*2	*2	☆	☆	☆	*1
	Form	☆	☆	☆	☆	☆	☆	☆	☆	☆	*2	*2	*2	*2	*2	☆	☆	☆	☆	☆	☆	☆	*1	-	*2	*2	*2	*2	*2	*2	☆	☆	☆	*1
	Date Stamp	☆	☆	☆	☆	☆	☆	☆	☆	☆	*2	*2	*2	*2	*2	☆	☆	☆	☆	☆	☆	☆	*2	*2	-	☆	☆	☆	*2	☆	☆	☆	*1	
	Page Stamp	☆	☆	☆	☆	☆	☆	☆	☆	☆	*2	*2	*2	*2	*2	☆	☆	☆	☆	☆	☆	☆	*2	*2	-	☆	☆	*2	☆	☆	☆	☆	*1	
	Stamp	☆	☆	☆	☆	☆	☆	☆	☆	☆	*2	*2	*2	*2	*2	☆	☆	☆	☆	☆	☆	☆	*2	*2	☆	☆	-	*2	*2	☆	☆	☆	*1	
	User Stamp	☆	☆	☆	☆	☆	☆	☆	☆	☆	*2	*2	*2	*2	*2	☆	☆	☆	☆	☆	☆	☆	*2	*2	☆	☆	*2	-	*2	☆	☆	☆	*1	
	Repeat	☆	☆	☆	☆	☆	☆	*2	☆	☆	*1	*1	*1	*1	*1	☆	☆	☆	☆	☆	☆	☆	*2	*2	*2	*2	*2	*2	-	*2	☆	☆	☆	*1
	Make-up	*2	☆	*2	☆	☆	☆	☆	☆	☆	☆	☆	☆	*2	*2	☆	☆	☆	☆	☆	☆	☆	☆	*1	*1	*2	*2	*2	*2	-	☆	☆	☆	*1
	Skip Feed	☆	☆	☆	☆	☆	☆	☆	☆	☆	☆	☆	☆	☆	☆	☆	☆	☆	☆	☆	☆	☆	☆	☆	☆	☆	☆	☆	☆	☆	☆	☆	☆	☆
	Sort	☆	☆	☆	☆	☆	☆	☆	☆	☆	☆	☆	☆	☆	☆	☆	☆	*2	*2	*2	*2	X	☆	☆	☆	☆	☆	☆	☆	☆	☆	☆	☆	☆
	Class Sort	☆	☆	☆	☆	☆	☆	☆	☆	☆	☆	☆	☆	☆	☆	☆	☆	*2	*2	*2	*2	X	☆	☆	☆	☆	☆	☆	☆	☆	☆	*1	-	*1
On Line	*2	☆	*2	☆	*2	*2	*2	*2	*2	*2	*2	*2	*2	*2	☆	☆	☆	☆	☆	☆	☆	*2	*2	*2	*2	*2	*2	*2	☆	☆	☆	X	-	
Image Rotation	☆	☆	☆	☆	☆	☆	☆	X	X	X	X	☆	☆	☆	☆	☆	☆	☆	☆	☆	☆	☆	X	X	X	X	X	X	☆	☆	☆	☆	X	
Master Saving	☆	☆	☆	☆	☆	☆	☆	☆	☆	☆	☆	☆	☆	☆	☆	☆	☆	☆	☆	☆	☆	☆	☆	☆	☆	☆	☆	☆	☆	☆	☆	☆	X	

4. User Tools

Accessing the User Tools

The user tools allow you to customize various default settings. This section is intended for the machine administrator.

- 1 Press the **[User Tools]** key.

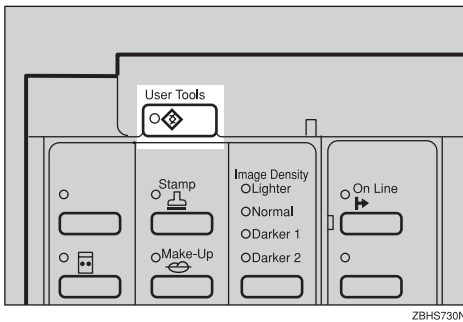

- 2 Select the desired user tools menu. See ⇒ P.141 "User Tools Menu".

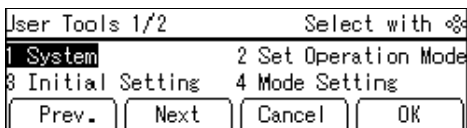

Using the **[<]**, **[>]**, **[Δ]**, or **[∇]** key

- 1 Search for the desired user tool number (1 to 6) with the **[<]**, **[>]**, **[Δ]**, or **[∇]** key.

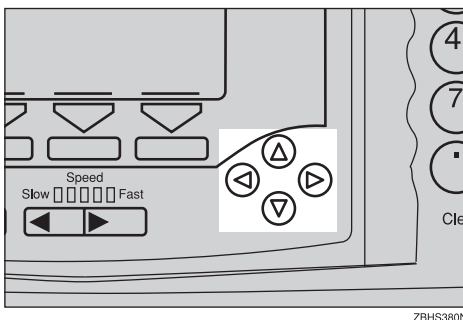

Note

- [Next]**: Press to go to the next page.
- [Prev.]**: Press to go back to the previous page.

- 2 Press the **[OK]** key.
- 3 Search for the desired user tool number of each function with the **[<]**, **[>]**, **[Δ]**, or **[∇]** key.
- 4 Press the **[OK]** key.

Using the Number keys

- 1 Enter the desired user tool number (1 to 6) with the Number keys.

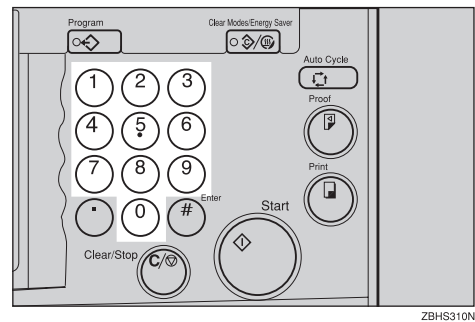

- 2 Press the **[OK]** or **[#]** key.
- 3 Enter the desired user tool number of each function with the Number keys.
- 4 Press the **[OK]** or **[#]** key.
- 3 Change the settings by following the instructions on the panel display. Then press the **[OK]** key.

 **Note**

- To change the value entered, press the **[Clear/Stop]** key before pressing the **[OK]** key. Then enter the new value.
- [Cancel]**: Press to return to the previous menu without changing any data.

4 Press the **[User Tools]** key to return to the standby display.

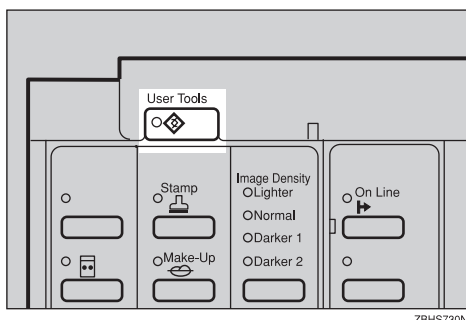

ZBHS730N

 **Note**







- The settings are not canceled even if the main switch is turned off or the **[Clear Modes/ Energy Saver]** key is pressed.
- You can also return to the standby display by pressing the **[Cancel]** key.





User Tools Menu

Reference





For how to access the user tools, see ⇒ P.139 “Accessing the User Tools”.

1. System









No.	Mode	Description
1	Auto Reset	<p>The machine returns to its initial condition automatically after your job is finished. The automatic reset time can be set from 1 to 5 minutes or off (0 minute).</p> <p> Note</p> <p><input type="checkbox"/> Default: <i>Off</i></p>
2	R. Counter Display	<p>Use to display the total number of masters and prints.</p> <p> Note</p> <p><input type="checkbox"/> A trial print delivered to the paper delivery tray after pressing the [Start] key will not be counted.</p>
3	Reset R. Counter	<p>Choose whether the total number of masters and prints is reset.</p> <p> Note</p> <p><input type="checkbox"/> Default: <i>Not clear</i></p>
4	Set User Code	<p>Selects User Code mode. For details about User Code mode, see ⇒ P.154 “6. Set User Code(s)” Use Code(s). Input key Operator Code if you have already set it. ⇒ P.154 “6. Set User Code(s)”</p> <p> Note</p> <p><input type="checkbox"/> Default: <i>Not to use</i></p>
6	mm/inch	<p>Choose the units of measurement shown on the panel display.</p> <p> Note</p> <p><input type="checkbox"/> Default:</p> <ul style="list-style-type: none"> • Metric version: <i>mm</i> • Inch version: <i>inch</i>
7	Language on LCD	<p>The language used for panel display messages can be selected.</p> <p> Note</p> <p><input type="checkbox"/> Default: <i>English</i></p>





No.	Mode	Description
8	Time Setting	Use to set the machine's internal clock.  Note <input type="checkbox"/> The clock must be adjusted if you change the clock to daylight saving time/summer time, or return to standard time.  Reference For how to set the clock, see ⇒ P.156 "1-8 Time Setting".
9	Auto Online	Specifies whether On Line mode is automatically selected when the machine detects the data from the personal computer.  Note <input type="checkbox"/> Default: <i>ON</i>
10	Data Print	Use to print out the following data.  Note <input type="checkbox"/> Available settings: <ul style="list-style-type: none"> • Log Data (Number of prints made, how many times paper misfeeds occur and so on.) • Reset Counters (Number of prints and master made under each user code.) • Store Class (Registered number of students in each class.)
11	Energy Saving	You can set the time until the Energy Saver mode starts.  Note <input type="checkbox"/> Default: 3 <i>Min.</i> (minutes)

2. Set Operation Mode







No.	Mode	Description
1	Min. Quantity	<p>The minimum print quantity can be set between 0 and 9999. Example: If you specify 20 as minimum number of prints, runs of 20 or more prints will be accepted, runs of less than 20 prints will not be accepted.</p> <p> Note <input type="checkbox"/> Default: 0</p>
2	Max. Quantity	<p>The maximum print quantity can be set between 0 and 9999.</p> <p> Note <input type="checkbox"/> Default: 9999</p>
3	CopyCount Display	<p>The counter can be set to show the number of prints made (Up), or the number of prints remaining to be made (Down).</p> <p> Note <input type="checkbox"/> Default: <i>Down</i></p>
5	Panel Beeper	<p>Turns the beeper on or off.</p> <p> Note <input type="checkbox"/> Default: <i>STD.</i> (standard) <input type="checkbox"/> Available settings:</p> <ul style="list-style-type: none"> • ALL OFF (The beeper does not sound when you press keys or when warning messages appear on the panel display.) • STD. (When you press a key, the beeper does not sound. When warning messages appear on the panel display, the beeper sounds.) • ALL ON (The beeper sounds when you press a key or when warning messages appear on the panel display.)
6	LCD Contrast	You can adjust the brightness of the panel display.
7	Delivery Capacity	<p>You can set the maximum number to make prints.</p> <p> Note <input type="checkbox"/> Default: <i>Yes</i> (1000 sheets)</p>





3. Initial Setting







No.	Mode	Description
1	Paper Type	Specifies the paper type at power on.  Note <input type="checkbox"/> Default: <i>Std.</i> (Standard)
2	MSTR Makg. Density	Specifies the image density at power on.  Note <input type="checkbox"/> Default: <i>Std.</i> (Standard)
3	Original Priority	Specifies the original mode at power on.  Note <input type="checkbox"/> Default: <i>Letter</i>
4	Reproduction Ratio	Adjust a fixed reproduction ratio between 50 and 200%.  Note <input type="checkbox"/> Default: <ul style="list-style-type: none"> • Metric version: 71%, 82%, 87%, 93%, 100%, 115%, 122%, 141% • Inch version: 65%, 74%, 77%, 93%, 100%, 121%, 129%, 155%  Reference For how to set the ratios, see ⇒ P.156 “3-4 Reproduction Ratio” 3-4 Reproduction ratio.
5	Class Enter No.	Before using All Class or Auto Class mode, register the number of students in each class with this function.  Note <input type="checkbox"/> You can store student numbers for up to 9 grades with 12 classes in each, giving a maximum of 108 classes. Each class can have up to 9999 students.  Reference For how to register the number of students, see ⇒ P.157 “3-5 Class Enter No.” 3-5 Class NO.
6	Photo(Lightness)	Specifies the lightness in Photo or Letter/Photo mode when you press the [Original] key.  Note <input type="checkbox"/> Default: <i>Std.</i> (Standard)



No.	Mode	Description
7	Photo(Screen)	<p>Specifies the screen image in Photo mode when you press the [Original] key.</p> <p> Note <input type="checkbox"/> Default: <i>Std.</i> (Standard)</p>
8	Tint Mode ON/OFF	<p>Specifies whether Tint mode is selected at power on.</p> <p> Note <input type="checkbox"/> Default: <i>OFF</i></p>
9	Margin Eras.Area	<p>Adjust the erase edges margin.</p> <p> Note <input type="checkbox"/> Default: <i>2mm, 0.1"</i></p> <p> Reference For how to adjust the erase edges area, see ⇒ P.158 "3-9 Margin Erase Area".</p>
10	Ppr. Size[On- line]	<p>Specifies the paper size when you press the [On Line] key.</p> <p> Note <input type="checkbox"/> Default: <i>Auto</i></p>
11	Ratio Priority	<p>You can set the ratio primarily displayed when you press the [Ratio] key.</p>







4. Mode Setting

No.	Mode	Description
1	Auto Cycle ON/OFF	Specifies whether Auto Cycle mode is selected at power on.  Note <input type="checkbox"/> Default: <i>ON</i>
2	Class Manual Set	You can use one original or multiple originals in Manual Class mode.  Note <input type="checkbox"/> Default: <i>Std. (One original)</i>
3	Ignore Paper Size	If you are making prints on non-standard paper and the original image does not entirely appear on the print, set paper size detection to "Ignore". The machine will not detect the length of paper.  Note <input type="checkbox"/> Default: <i>Not to ignore</i>
4	No Orig. Size(ADF)	When you set long originals in the optional document feeder, set original detection to "Ignore". The machine will not detect the original size.  Note <input type="checkbox"/> Default: <i>Not to ignore</i>
5	No Orig. Size	When you set originals of non standard sizes on the exposure glass (contact glass), set original detection to "Ignore". The machine will not detect the original size.  Note <input type="checkbox"/> Default: <i>Not to ignore</i>
6	Background ON/OFF	When you make prints in Photo, Letter/Photo, or Tint mode, the background of the prints might become dirty. Turn Background On to improve the clarity of your prints.  Note <input type="checkbox"/> Default: <i>W/O back. correction (off)</i>
7	Longer Paper	You can select whether you can use paper longer than 432mm, 17.0" or not.  Note <input type="checkbox"/> Default: <i>Not to use</i>

No.	Mode	Description
8	Combine	<p>If you select “Automatic (Auto Combine mode)”, you can make two or four identical images on the one sheet by pressing the [Combine] key and [Start] key.</p> <p> Note</p> <p><input type="checkbox"/> Default: <i>Normal</i> (Combine Originals mode)</p> <p> Reference</p> <p>For how to use Auto Combine mode, see ⇒ P.67 “Auto Combine Mode—Having Images Repeated on one Print”.</p>
9	Comb. Sep. Line	<p>You can select a separation line in Memory Combine mode.</p> <p> Limitation</p> <p><input type="checkbox"/> You can use this function only when you have an optional memory board.</p> <p> Note</p> <p><input type="checkbox"/> Default: <i>None</i></p> <p><input type="checkbox"/> Available settings:</p> <div data-bbox="522 877 985 1074" style="border: 1px solid black; padding: 5px; margin: 10px 0;"> <p style="text-align: right; font-size: small;">GRLINEOE</p> </div> <ul style="list-style-type: none"> • a = None • b = Solid • c = Broken1 • d = Broken2 • e = CropMarks
10	Cancel Comb.	<p>Specifies whether Combine Originals or Memory Combine mode is cleared after finishing your print job.</p> <p> Note</p> <p><input type="checkbox"/> Default: <i>Not to cancel</i></p>

No.	Mode	Description
11	No. of Skip Feed	<p>Specifies the number of drum rotations in Skip Feed mode at power on. You can also select whether you can change the number of drum rotations temporarily when you press the [Skip Feed] key. See ⇒ P.69 “Skip Feed Printing”.</p> <p> Note</p> <p><input type="checkbox"/> Default:</p> <ul style="list-style-type: none"> • Panel display: <i>Display</i> • Number of Skip Feed: 2 <p> Reference</p> <p>For how to change number of rotations, see ⇒ P.159 “4-11 No. of Skip Feed”.</p>
12	Idling for Q.start	<p>When you use the Manual Quality Start function, you can select how many times the drum unit idles.</p> <p> Note</p> <p><input type="checkbox"/> Default: 45</p>
13	Setting Q.start	<p>If the machine is not used for a long period of time, the ink on the drum might dry causing image quality to deteriorate. The Auto Quality Start function automatically recovers image density quality after a selected time has passed. If Auto Quality Start is set to “Not to use”, you can regain print quality by making a few extra prints or you can use Manual Quality Start mode.</p> <p> Note</p> <p><input type="checkbox"/> Default: <i>To use</i></p>
14	No. of Q.start	<p>You can select how many times the drum unit idles after the following time periods have passed in Auto Quality Start mode.</p> <p> Note</p> <p><input type="checkbox"/> Default: See ⇒ P.160 “4-14 No. of Q.start”.</p> <p><input type="checkbox"/> To increase the print image density, increase the number of drum rotations, and vice versa.</p> <p> Reference</p> <p>For how to change the number of idle spins, see ⇒ P.160 “4-14 No. of Q.start”.</p>







No.	Mode	Description
15	Deflector Angle	<p>You can change the angle of the wing guide depending on the paper type you use.</p> <p> Note</p> <p><input type="checkbox"/> Default: <i>Auto</i></p> <p><input type="checkbox"/> Available settings:</p> <ul style="list-style-type: none"> • Up (Select this setting when standard thickness or thin paper misfeeds at the paper exit section occur frequently.) • Down (Select this setting when A4 – B5, 8¹/₂" × 11" thick paper is not delivered properly to the paper delivery tray.)
16	Auto Class	<p>When you do not use the Job Separation function, you can select the machine's condition after each printing set is fed out to the paper delivery tray.</p> <p> Note</p> <p><input type="checkbox"/> Default: <i>Stop</i></p> <p><input type="checkbox"/> Available settings:</p> <ul style="list-style-type: none"> • Start printing automatically (After the last page of each printing set is fed out to the paper delivery tray, the machine stops for a few seconds. Then, the next cycle begins.) • Stop (After the last page of each printing set is fed out to the paper delivery tray, the machine stops. If you press the [Print] key, the next cycle begins.)
17	Auto Separate	<p>Specifies whether Job Separation mode is automatically carried out when you make prints in All Class, Auto Class, Manual Class, or Class mode.</p> <p> Note</p> <p><input type="checkbox"/> Default: <i>ON</i></p>











No.	Mode	Description
18	Ink/Master Left	<p>Specifies whether you can check the amount of ink and master.</p> <p> Note</p> <p><input type="checkbox"/> Default: <i>OFF</i></p> <p><input type="checkbox"/> Available settings:</p> <ul style="list-style-type: none"> • OFF (You cannot check the remaining amount of ink or master.) • ON (When the remaining amount of ink or master is less than half, the panel display indicates these amounts when you turn on the main switch.) • Check remaining volume (You can see the remaining amounts of ink and master regardless of these amounts.)
19	Type of Paper	<p>When one kind of paper misfeeds occur frequently, you can register its paper type in "User1" or "User2".</p> <p> Reference</p> <p>For how to register a special paper type, see ⇒ P.161 "4-19 Type of Paper".</p>
20	Auto Rotation	<p>When the direction in which your original is set is different from that of the paper, and your machine is equipped with the optional memory board, the machine automatically rotates the original image by 90° to match the paper direction. You can cancel this setting.</p> <p> Note</p> <p><input type="checkbox"/> Default: <i>ON</i></p>
21	Master length	<p>The machine determines the master length according to the number of originals set in the optional document feeder and the paper sizes. If you wish to use A3/11"×17" master regardless of the number of originals set and the paper sizes, select "A3".</p> <p> Note</p> <p><input type="checkbox"/> Default: <i>Auto</i></p>
25	Jogger	<p>You can set priority for the image or aligning the prints when using the sorter.</p> <p> Note</p> <p><input type="checkbox"/> Default: <i>Every page</i></p>
27	Adjusting sharpness of letters	<p>Adjusts the sharpness of text in Letter mode.</p> <p> Note</p> <p><input type="checkbox"/> Default: <i>Standard</i></p> <p><input type="checkbox"/> When "Thin Lettering" is selected, shadows of pasted originals might appear on prints.</p>





5. Stamp

Note

You can use these functions only when you have an optional memory board.

No.	Mode	Description
1	Type	<p>You can change the message selected at power on with the Stamp function.</p> <p> Note</p> <p><input type="checkbox"/> Default: <i>CONFIDENTIAL</i></p>
2	Size	<p>You can edit the preset stamp sizes.</p> <p> Note</p> <p><input type="checkbox"/> Default: <i>Standard</i> (about 32 × 64mm)</p> <p><input type="checkbox"/> Adjustment values:</p> <ul style="list-style-type: none"> • Double size • 4 (4 times) • 8 (8 times)
3	Stamp Density	<p>You can select the style of the stamps.</p> <p> Note</p> <p><input type="checkbox"/> Default: <i>Solid-fill</i></p>
4	Stamp Position	<p>You can edit the preset stamp position.</p> <p> Note</p> <p><input type="checkbox"/> Default: See ⇒ P.162 “5-4 Stamp Position”.</p> <p><input type="checkbox"/> Available settings: See ⇒ P.162 “5-4 Stamp Position”.</p> <p> Reference</p> <p>For how to adjust the stamp position, see ⇒ P.162 “5-4 Stamp Position”.</p>
5	Size(User Stamp)	<p>You can edit the user stamp sizes.</p> <p> Note</p> <p><input type="checkbox"/> Default: <i>Standard</i> (about 32 × 64mm)</p> <p><input type="checkbox"/> Available settings:</p> <ul style="list-style-type: none"> • Double size • 4 (4 times) • 8 (8 times)









No.	Mode	Description
6	Density(User)	<p>You can select the style of user stamps.</p> <p> Note</p> <p><input type="checkbox"/> Default: <i>Solid-fill</i></p>
7	Position(User)	<p>You can edit the user stamp position.</p> <p> Note</p> <p><input type="checkbox"/> Default: See ⇒ P.163 “5-7 Position (User)”.</p> <p><input type="checkbox"/> Available settings: See ⇒ P.163 “5-7 Position (User)”.</p> <p> Reference</p> <p>For how to adjust the stamp position, see ⇒ P.163 “5-7 Position (User)”.</p>
8	Regist.(User)	<p>You can register user stamps.</p> <p> Note</p> <p><input type="checkbox"/> Registered user stamps cannot be deleted. If you want to change a registered stamp, overwrite it.</p> <p> Reference</p> <p>For how to register a user stamp, see ⇒ P.165 “5-8 Regist. (User)”.</p>
9	Date Style Set	<p>You can select the style of the date stamp.</p> <p> Note</p> <p><input type="checkbox"/> Default: <i>Month Day Year</i></p>
10	Date Position Set	<p>You can select the date stamp direction at power on in Date Stamp mode.</p> <p> Note</p> <p><input type="checkbox"/> Default: <i>Upper Left</i></p>
11	Position(Date)	<p>You can edit the date stamp position.</p> <p> Note</p> <p><input type="checkbox"/> Default: See ⇒ P.166 “5-11 Position (Date)”.</p> <p><input type="checkbox"/> Available settings: See ⇒ P.166 “5-11 Position (Date)”.</p> <p> Reference</p> <p>For how to adjust the date stamp position, see ⇒ P.166 “5-11 Position (Date)”.</p>
12	Type(Page)	<p>You can select the page numbering style at power on in Page Stamp mode.</p> <p> Note</p> <p><input type="checkbox"/> Default: <i>P1,P2</i></p>



No.	Mode	Description
13	Direction(Page)	<p>You can select the page numbering direction at power on in Page Stamp mode.</p> <p> Note</p> <p><input type="checkbox"/> Default:</p> <ul style="list-style-type: none"> • When you select “P1,P2” or “1/5,2/5” with the “Type(Page)” user tool: <i>Upper Right</i> • When you select “-1,-2-” with the “Type(Page)” user tool: <i>Down centre</i>
14	Position(Page)	<p>You can edit the page numbering position.</p> <p> Note</p> <p><input type="checkbox"/> Default: See ⇒ P.167 “5-14 Position (Page)”.</p> <p><input type="checkbox"/> Available settings: See ⇒ P.167 “5-14 Position (Page)”.</p> <p> Reference</p> <p>For how to adjust the page numbering position, see ⇒ P.167 “5-14 Position (Page)”.</p>
15	Make/Chg. Pattern	<p>Make your own background pattern in Make-up mode.</p> <p> Note</p> <p><input type="checkbox"/> You can edit the 40 preset patterns.</p> <p> Reference</p> <p>For how to change the background pattern, see ⇒ P.168 “5-15 Make/Chg. Pattern”.</p>

6. Set User Code(s)

❖ User Codes

If user codes are turned on, operators must input their user codes before they can operate the machine. The machine keeps count of the number of copies made under each user code. Turn this function on with the “Set User Code(s)” user tool. You can also turn on Key Operator Codemode so that only the key operator (administrator) can use the functions below.

1	Check Counter	<p>You can check the number of masters and copies made under each user code.</p> <p> Reference For how to check the number of masters and copies, see ⇒ P.169 “6-1 Check Counter”.</p>
2	Reset Counters	<p>You can clear each or all user code counters.</p> <p> Note <input type="checkbox"/> Default: <i>Single</i></p> <p> Reference For how to clear the number of masters and copies, see ⇒ P.170 “6-2 Reset Counters”.</p>
3	Reg. User Code	<p>You can register user codes.</p> <p> Note <input type="checkbox"/> Up to 20 user codes (up to 4 digits) can be registered.</p>
4	Chg. User Code	<p>You can change user codes.</p> <p> Note <input type="checkbox"/> The number of copies made under the old code is added to that made under the new user code.</p> <p> Reference For how to change the user codes, see ⇒ P.170 “6-4 Chg. User Code”.</p>
5	Del. User Code	<p>You can delete user codes.</p> <p> Note <input type="checkbox"/> The number of copies made under the deleted code is also deleted.</p> <p> Reference For how to delete user codes, see ⇒ P.171 “6-5 Del. User Code”.</p>

6	Key Operator Code	Use to turn Key Operator Code mode on or off.  Note <input type="checkbox"/> Default: <i>Not to use</i>
7	Reg/Chg KeyOp-Code	You can register or change key operator codes. (up to 4 digits)
8	Restricted Access	In Key Counter mode, you have to set the key counter before making prints. (To turn on Key Counter mode, contact your service representative.) If Key Counter mode is on, Restricted Access is turned on ("To use") automatically. If you turn Restricted Access off ("Not to use"), you can make prints without inserting the key counter.  Note <input type="checkbox"/> Default: <i>Not to use</i>

User Tool Menus in Detail

1-8 Time Setting

1 Press the **[User Tools]** key.

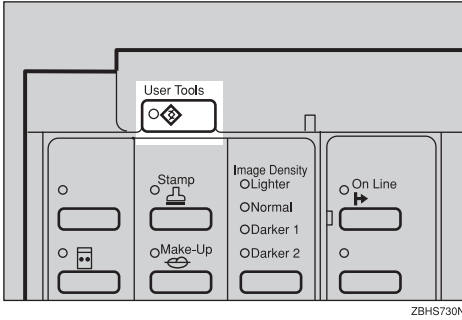

2 Make sure that "1" is selected. Then press the **[OK]** key.

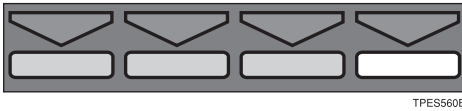
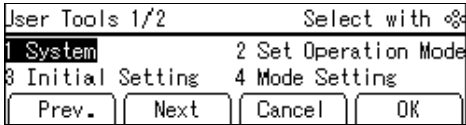

3 Enter 8 with the Number keys. Then press the **[OK]** or **[#]** key.

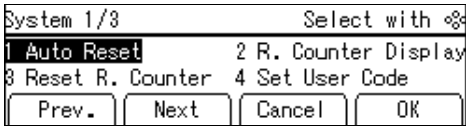

4 Enter the year with the Number keys.

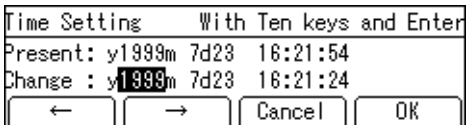

5 Press the **[#]** key.

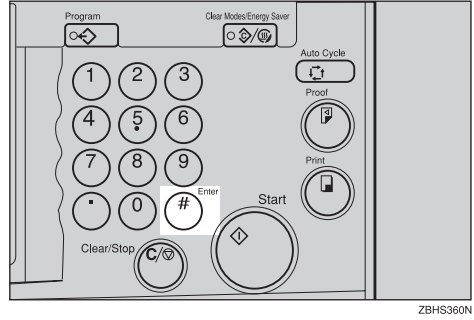

6 Input the month with the Number keys.

7 Press the **[Enter]** key.

Note

- Follow steps **6** and **7** for the "date", "hour", "minute", and "second".

8 Press the **[OK]** key.

3-4 Reproduction Ratio

1 Press the **[User Tools]** key.

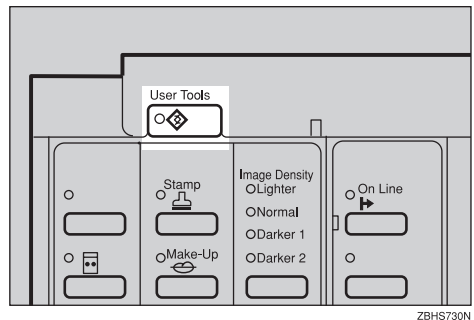

- 2** Enter 3 with the Number keys. Then press the [OK] or [#] key.

User Tools 1/2		Select with ⌘	
1 System	2 Set Operation Mode		
3 Initial Setting	4 Mode Setting		
Prev.	Next	Cancel	OK

- 3** Enter 4 with the Number keys. Then press the [OK] or [#] key.

User Tools 1/3		Select with ⌘	
1 Paper Type	2 MSTR Makg. Density		
3 Original Priority	4 Reproduction Ratio		
Prev.	Next	Cancel	OK

- 4** Select the ratio you want to adjust with the [←] [→] or [◀] [▶] keys.

Reproduction Ratio		Select with <-->	
71	82	87	93
		100	115
			122
			141
←	→	Adjust.	OK



TPES530E

- 5** Press the [Adjust.] key.
- 6** Enter the desired ratio with the [←] [→] or [◀] [▶] keys.

Note

- You can also enter the ratio with the Number keys.

- 7** Press the [OK] key twice.

3-5 Class Enter No.

- 1** Press the [User Tools] key.

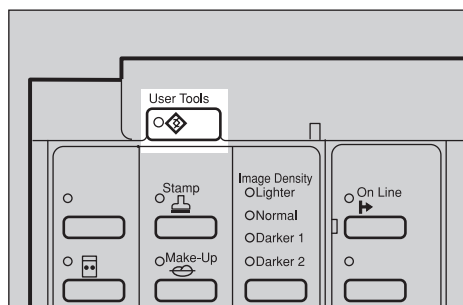

ZBHS730N

- 2** Enter 3 with the Number keys. Then press the [OK] or [#] key.

User Tools 1/2		Select with ⌘	
1 System	2 Set Operation Mode		
3 Initial Setting	4 Mode Setting		
Prev.	Next	Cancel	OK

- 3** Enter 5 with the Number keys. Then press the [OK] or [#] key.

User Tools 1/3		Select with ⌘	
1 Paper Type	2 MSTR Makg. Density		
3 Original Priority	4 Reproduction Ratio		
Prev.	Next	Cancel	OK

- 4** Select the grade with the [←] [→] or [◀] [▶] keys.

Class Enter No.		Select with <-->	
1	[2]	[3]	[4]
		[5]	[6]
			[7]
			[8]
			[9]
←	→	Enter	OK



TPES530E

- 5** Press the [Enter] key.

- 6** Select the class with the [←] [→] or [◀] [▶] keys.

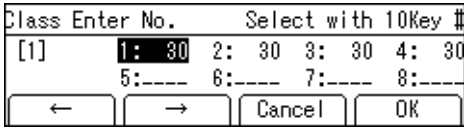

TPES530E

- 7** Enter the number of students with the Number keys. Then press the [#] key.

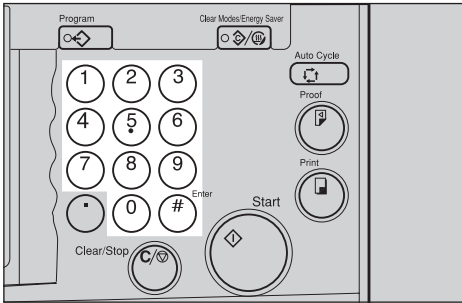

ZBHS720N

Note

- Repeat steps **6** and **7** until you have finished registering number of students in each class.

- 8** Press the [OK] key.

Note

- Repeat steps **4** through **8** until you have finished registering number of students in each class for the other grades.

- 9** Press the [OK] key.

3-9 Margin Erase Area

- 1** Press the [User Tools] key.

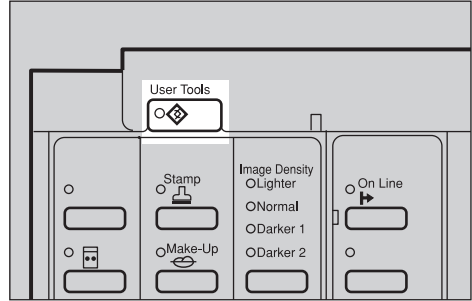

ZBHS730N

- 2** Enter 3 with the Number keys. Then press the [OK] or [#] key.

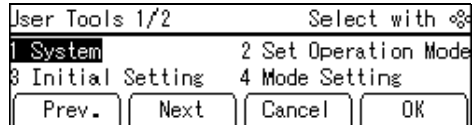

- 3** Enter 9 with the Number keys. Then press the [OK] or [#] key.

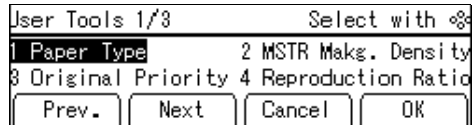

- 4** Select the original size you will use with the [←] [→] or [◀] [▶] keys.

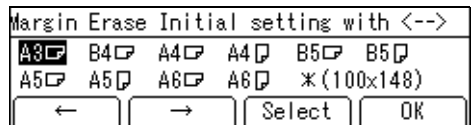

TPES530E

- 5** Press the [Select] key.

- 6** Adjust the erase edge margin.

If you selected A3 to A6 or 11" × 17" to 5¹/₂" × 8¹/₂"

- 1 Adjust the erase edge margin with the [←] [→] or [◀] [▶] keys.

Set Erase Area with 10Key			
A3 : Width to erase 4mm			
(←→ or 10Key, press #)			
←	→	Cancel	OK



TPES530E

Note

- You can also enter the ratio with the Number keys and the [#] key.

If you selected *

- 1 Enter the erase edge margin with the Number keys.

Set Erase Area with 10Key			
* : Width to erase 0mm			
Size ↑ 50mm → 58mm			
←	→	Cancel	OK

- 2 Press the [#] key.
- 3 Enter the vertical length of paper you use with the Number keys.
- 4 Press the [#] key.
- 5 Enter the horizontal width of paper you use with the Number keys.
- 6 Press the [#] key.
- 7 Press the [OK] key twice.

4-11 No. of Skip Feed

The following procedure explains how to change the number of drum rotations.

- 1 Press the [User Tools] key.

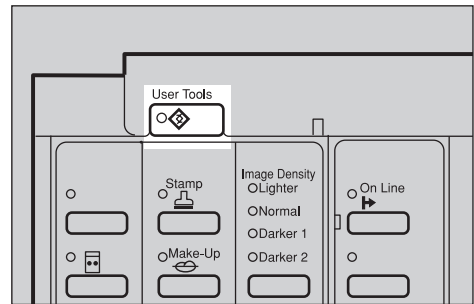

ZBHS730N

- 2 Enter 4 with the Number keys. Then press the [OK] or [#] key.

User Tools 1/2		Select with ⌘	
1 System	2 Set Operation Mode	3 Initial Setting	4 Mode Setting
Prev.	Next	Cancel	OK

- 3 Enter 11 with the Number keys. Then press the [OK] or [#] key.

Mode Setting 1/7		Select with ⌘	
1 Auto Cycle ON/OFF	2 Class Manual Set	3 Ignore Paper Size	4 No Orig. Size(ADF)
Prev.	Next	Cancel	OK

- 4 Press the [Change] key.

Skip Feed		Select with <-->	
Display	Not display	(Number of Skip Feed: 3)	
←	→	Change	OK



TPES520E

- Change the number of drum rotations while one sheet of paper is fed with the [←] [→] or [◀] [▶] keys.

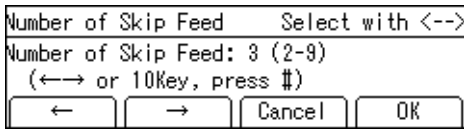

TPES530E

Note

- You can also change the number of rotations with the Number keys.

- Press the [OK] key.

4-14 No. of Q.start

Note

- The default settings are as follows:

		Time period			
		0 - 4 hours	4 - 24 hours	24 - 72 hours	More than 72 hours
Temperature	Low Tmp. *1	0	15	45	45
	Normal Tmp.*2	0	0	15	15
	High Tmp.*3	0	0	0	15

*1 (10 - 15°C, 50 - 59°F)

*2 (15 - 28°C, 59 - 82.4°F)

*3 (28 - 30°C, 82.4 - 86°F)

- Press the [User Tools] key.

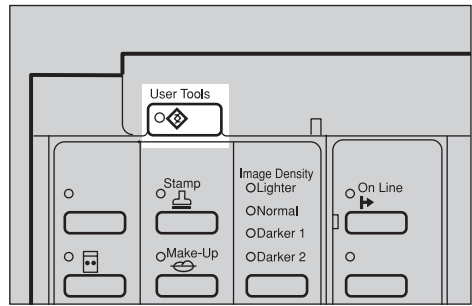

ZBHS730N

- Enter 4 with the Number keys. Then press the [OK] or [#] key.

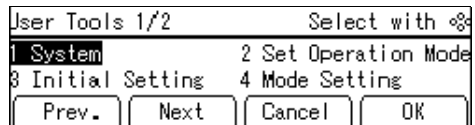

- Enter 14 with the Number keys. Then press the [OK] or [#] key.

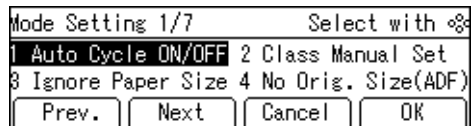

- Select the temperature at which you use this machine with the [←] [→] or [◀] [▶] keys.

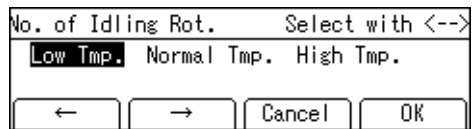

TPES530E

- Press the [OK] key.

- Select the time period you want to change how many times the drum unit idles with the [←] [→] or [◀] [▶] keys.

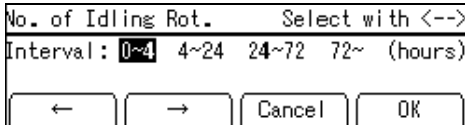

TPES530E

- Press the [OK] key.

- Select the number of drum rotations with the [←] [→] or [◀] [▶] keys.

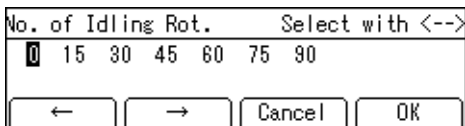

TPES530E

- Press the [OK] key.

4-19 Type of Paper

- Press the [User Tools] key.

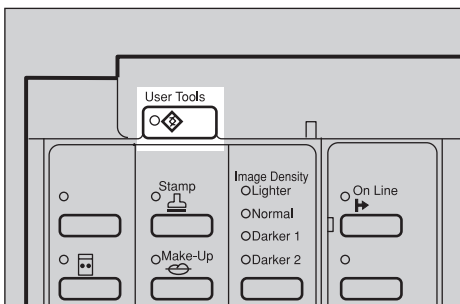

ZBHS730N

- Enter 4 with the Number keys. Then press the [OK] or [#] key.

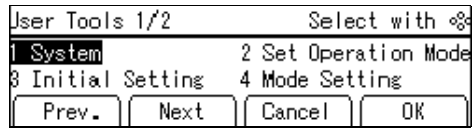

- Enter 19 with the Number keys. Then press the [OK] or [#] key.

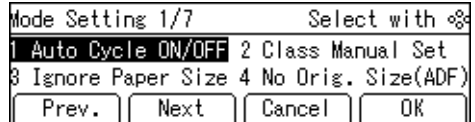

- Select [User1] or [User2] with the [←] [→] or [◀] [▶] keys.

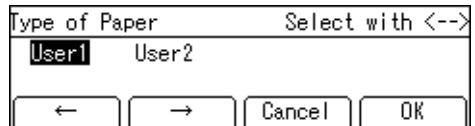

TPES530E

- Press the [OK] key.

- Select the paper type and misfeed condition with the [←] or [→] key.

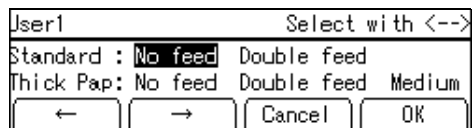

TPES530E

- Press the [OK] key.

- Press the [Cancel] key.

5-4 Stamp Position

Note

The default position and available settings of each stamp are as follows:

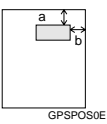
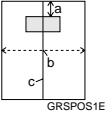
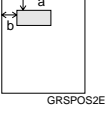
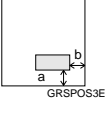
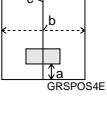
Stamp positions	Default	Available settings
	a = 24mm, 0.96" b = 24mm, 0.96"	a = 8 – 104mm, 0.32" – 4.16" b = 8 – 144mm, 0.32" – 5.76"
	a = 24mm, 0.96" b = 0mm, 0"	a = 8 – 104mm, 0.32" – 4.16" b = -72 – 72mm, -2.88" – 2.88"
	a = 24mm, 0.96" b = 24mm, 0.96"	a = 8 – 104mm, 0.32" – 4.16" b = 8 – 144mm, 0.32" – 5.76"
	a = 24mm, 0.96" b = 24mm, 0.96"	a = 8 – 104mm, 0.32" – 4.16" b = 8 – 144mm, 0.32" – 5.76"
	a = 24mm, 0.96" b = 0mm, 0" c = centre line	a = 8 – 104mm, 0.32" – 4.16" b = -72 – 72mm, -2.88" – 2.88"

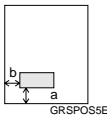
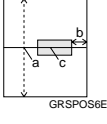
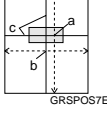
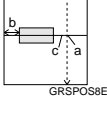
Stamp positions	Default	Available settings
	a = 24mm, 0.96" b = 24mm, 0.96"	a = 8 – 104mm, 0.32" – 4.16" b = 8 – 144mm, 0.32" – 5.76"
	a = 0mm, 0" b = 24mm, 0.96" c = centre line	a = -52 – 52mm, -2.08" – 2.08" b = 8 – 144mm, 0.32" – 5.76"
	a = 0mm, 0" b = 0mm, 0" c = centre line	a = -52 – 52mm, -2.08" – 2.08" b = -72 – 72mm, -2.88" – 2.88"
	a = 0mm, 0" b = 24mm, 0.96" c = centre line	a = -52 – 52mm, -2.08" – 2.08" b = 8 – 144mm, 0.32" – 5.76"

1 Press the **[User Tools]** key.

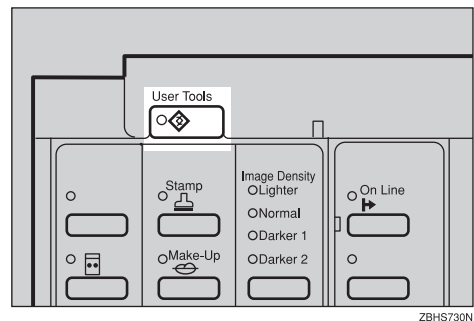

2 Enter 5 with the Number keys. Then press the **[OK]** or **[#]** key.

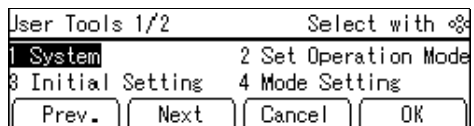

- Enter 4 with the Number keys. Then press the [OK] or [#] key.

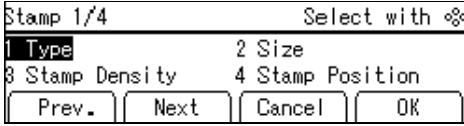

- Select the stamp position you want to adjust with the [←] [→] or [◀] [▶] keys.

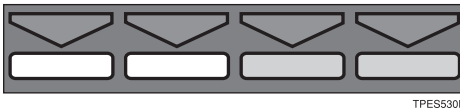
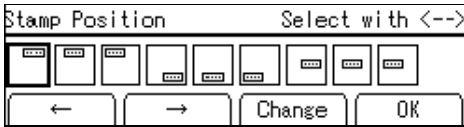

- Press the [Change] key.
- Adjust the horizontal stamp position with the [Δ] or [▽] key. Then press the [▶] key.

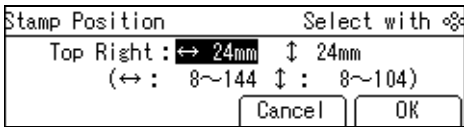

Note

- The value increases or decreases in 4mm, 0.16" steps.

- Adjust the vertical stamp position with the [Δ] or [▽] key.

- Press the [OK] key twice.

5-7 Position (User)

Note

- The default position and available settings of each user stamp are as follows:

Stamp positions	Default	Available settings
 GSPOS0E	a = 24mm, 0.96" b = 24mm, 0.96"	a = 8 – 104mm, 0.32" – 4.16" b = 8 – 144mm, 0.32" – 5.76"
 GRSP0S1E	a = 24mm, 0.96" b = 0mm, 0" c = centre line	a = 8 – 104mm, 0.32" – 4.16" b = -72 – 72mm, -2.88" – 2.88"
 GRSP0S2E	a = 24mm, 0.96" b = 24mm, 0.96"	a = 8 – 104mm, 0.32" – 4.16" b = 8 – 144mm, 0.32" – 5.76"
 GRSP0S3E	a = 24mm, 0.96" b = 24mm, 0.96"	a = 8 – 104mm, 0.32" – 4.16" b = 8 – 144mm, 0.32" – 5.76"
 GRSP0S4E	a = 24mm, 0.96" b = 0mm, 0" c = centre line	a = 8 – 104mm, 0.32" – 4.16" b = -72 – 72mm, -2.88" – 2.88"

4

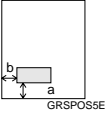
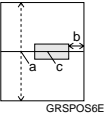
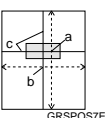
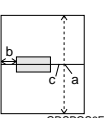
Stamp positions	Default	Available settings
	a = 24mm, 0.96" b = 24mm, 0.96"	a = 8 – 104mm, 0.32" – 4.16" b = 8 – 144mm, 0.32" – 5.76"
	a = 0mm, 0" b = 24mm, 0.96" c = centre line	a = - 52 – 52mm, - 2.08" – 2.08" b = 8 – 144mm, 0.32" – 5.76"
	a = 0mm, 0" b = 0mm, 0" c = centre line	a = - 52 – 52mm, - 2.08" – 2.08" b = - 72 – 72mm, - 2.88" – 2.88"
	a = 0mm, 0" b = 24mm, 0.96"	a = - 52 – 52mm, - 2.08" – 2.08" b = 8 – 144mm, 0.32" – 5.76"

1 Press the [User Tools] key.

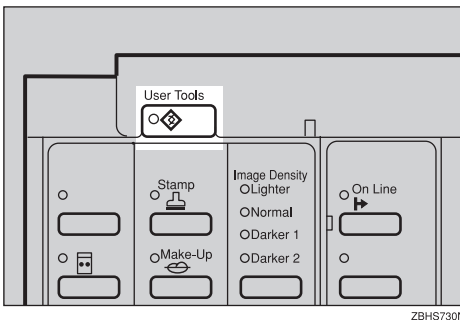

2 Enter 5 with the Number keys. Then press the [OK] or [#] key.

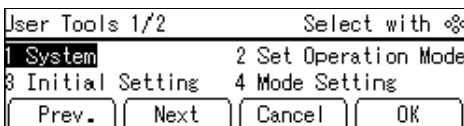

3 Enter 7 with the Number keys. Then press the [OK] or [#] key.

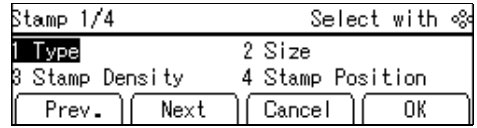

4 Select the user stamp position you want to adjust with the [←] [→] or [◀] [▶] keys.

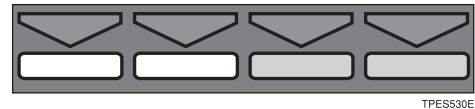
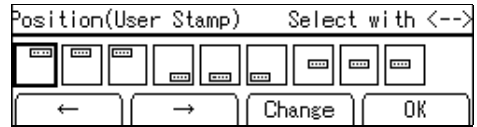

5 Press the [Change] key.

6 Adjust the horizontal user stamp position with the [△] or [▽] key. Then press the [▶] key.

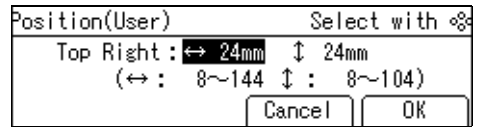

Note

The value increases or decreases in 4mm, 0.16" steps.

7 Adjust the vertical user stamp position with the [△] or [▽] key.

8 Press the [OK] key twice.

5-8 Regist. (User)

1 Press the **[User Tools]** key.

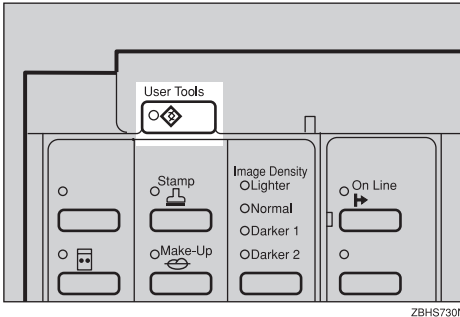

2 Enter 5 with the Number keys. Then press the **[OK]** or **[#]** key.

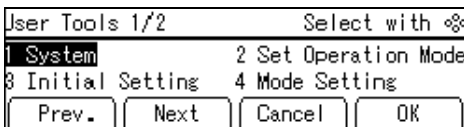

3 Enter 8 with the Number keys. Then press the **[OK]** or **[#]** key.

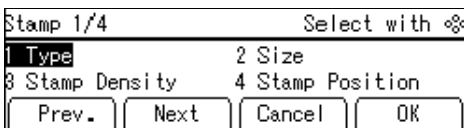

4 Select one of the four available user stamps with the **[←]** **[→]** or **[<]** **[>]** keys.

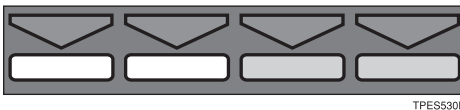
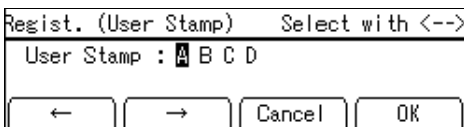

Note

- If the stamp you choose is already being used, the machine asks whether you wish to overwrite it or not. Select the **[Yes]** or **[No]** key.

5 Press the **[OK]** key.

6 Set the original you want to register as a user stamp on the exposure glass (contact glass).

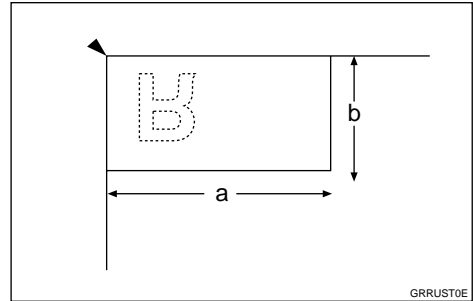

a: 64mm, 2.5"

b: 32mm, 1.2"

Note

- The image area as shown in the illustration will be registered as a user stamp.

7 Press the **[Start]** key.

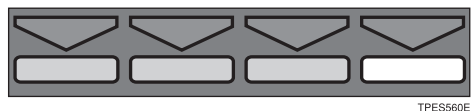
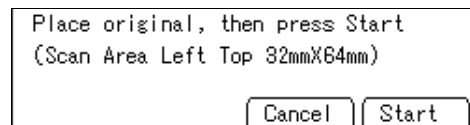

8 Press the **[User Tools]** key.

5-11 Position (Date)

Note

The default position and available settings of each date stamp are as follows:

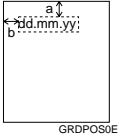
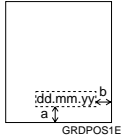
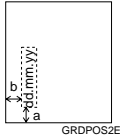
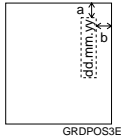
Stamp positions	Default	Available settings
 <p>GRDPOS1E</p>	a = 8mm, 0.32" b = 20mm, 0.80"	a = 8 – 40mm, 0.32" – 1.60" b = 8 – 40mm, 0.32" – 1.60"
 <p>GRDPOS1E</p>		
 <p>GRDPOS2E</p>	a = 20mm, 0.80" b = 12mm, 0.48"	
 <p>GRDPOS3E</p>	a = 20mm, 0.80" b = 8mm, 0.32"	

1 Press the [User Tools] key.

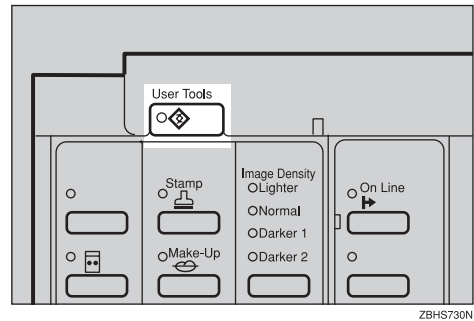

2 Enter 5 with the Number keys. Then press the [OK] or [#] key.

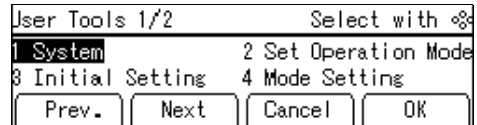

3 Enter 11 with the Number keys. Then press the [OK] or [#] key.

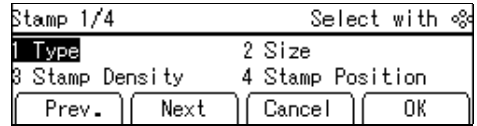

4 Select the date stamp direction you want to adjust with the [←] [→] or [◀] [▶] keys.

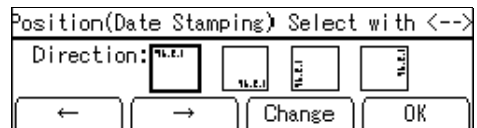

5 Press the [Change] key.

- 6** Adjust the horizontal date stamp position with the [Δ] or [▽] key. Then press the [▷] key.

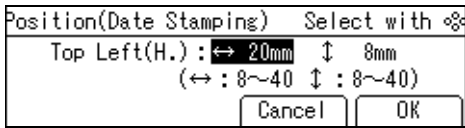

Note

- The value increases or decreases in 4mm, 0.16" steps.

- 7** Adjust the vertical date stamp position with the [Δ] or [▽] key.

- 8** Press the [OK] key twice.

5-14 Position (Page)

Note

- The default position and available settings of each page stamp are as follows:

❖ P1 or 1/5

Stamp positions	Default	Available settings
	a = 8mm, 0.32" b = 12mm, 0.48"	a = 8 – 40mm, 0.32" – 1.60" b = 8 – 40mm, 0.32" – 1.60"
	a = 12mm, 0.48" b = 12mm, 0.48"	

❖ -1-

Stamp positions	Default	Available settings
	a = 8mm, 0.32"	a = 8 – 40mm, 0.32" – 1.60"
	a = 8mm, 0.32"	a = 8 – 40mm, 0.32" – 1.60"

- 1** Press the [User Tools] key.

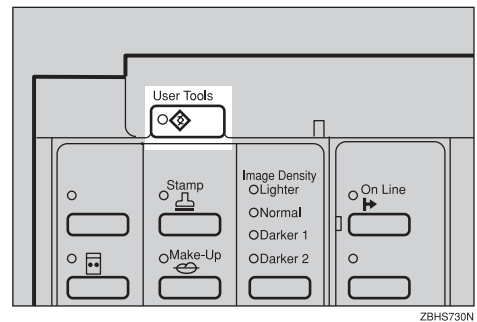

- 2** Enter 5 with the Number keys. Then press the [OK] or [#] key.

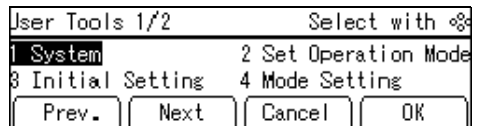

- 3** Enter 14 with the Number keys. Then press the [OK] or [#] key.

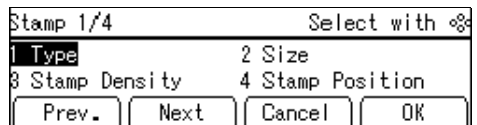

- 4** Select the page numbering direction you want to adjust with the [←] [→] or [↶] [↷] keys.

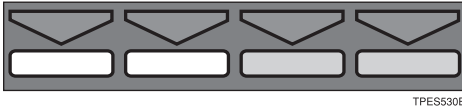
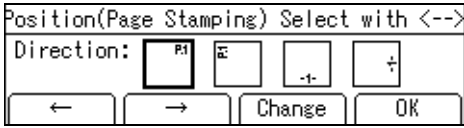

TPES530E

- 5** Press the [Change] key.

- 6** Adjust the horizontal page numbering position with the [Δ] or [∇] key. Then press the [▷] key.

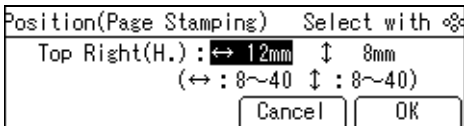

Note

- The value increases or decreases in 4mm, 0.16" steps.

- 7** Adjust the vertical page numbering position with the [Δ] or [∇] key.

Note

- You need not follow step 7 when you select "-1-" as the direction in step 4.

- 8** Press the [OK] key twice.

5-15 Make/Chg. Pattern

- 1** Press the [User Tools] key.

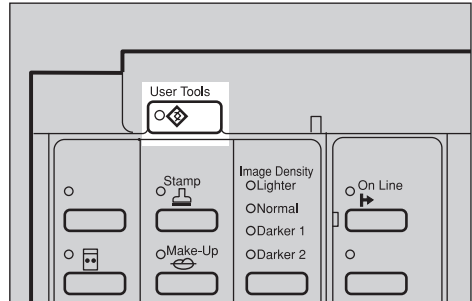

ZBHS730N

- 2** Enter 5 with the Number keys. Then press the [OK] or [#] key.

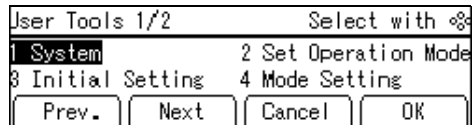

- 3** Enter 15 with the Number keys. Then press the [OK] or [#] key.

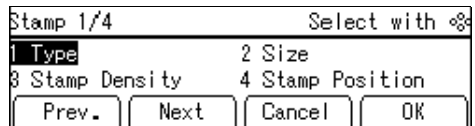

- 4** Select the background pattern with the [◀], [▶], [Δ], or [∇] key.

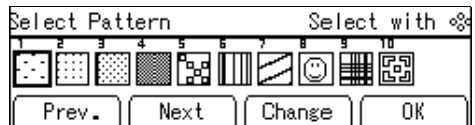

- 5** Press the [Change] key.

- 6** Move the cursor to the position you wish to edit with the [◀], [▶], [Δ], or [∇] key.

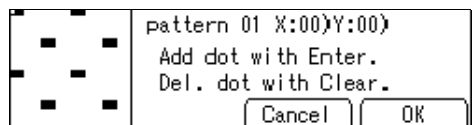

- 7** Press the **[#]** or **[Clear/Stop]** key to edit the pattern.

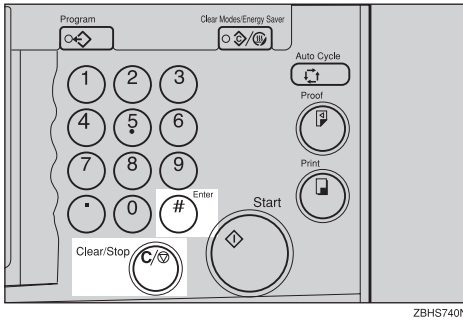

Note

- To add a dot, press the **[#]** key.
- To remove a dot, press the **[Clear/Stop]** key.
- Repeat steps **6** and **7** until you have finished editing the pattern.

- 8** Press the **[OK]** key twice.

6-1 Check Counter

- 1** Press the **[User Tools]** key.

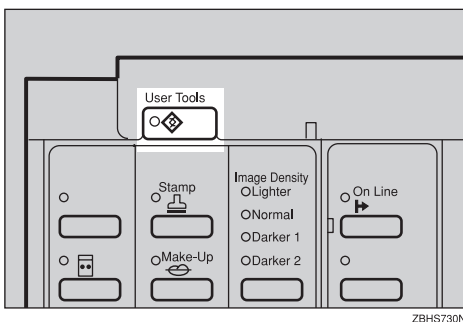

- 2** Enter 6 with the Number keys. Then press the **[OK]** or **[#]** key.

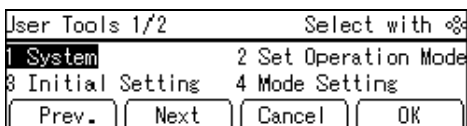

- 3** Make sure that 1 is selected. Then press the **[OK]** key.

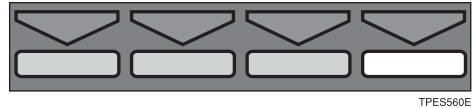
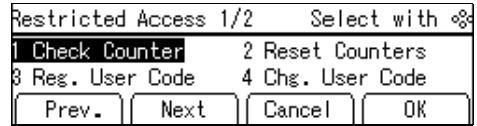

Note

- The number of masters and prints made under the first user code will be displayed in the panel display.

- 4** Keep pressing the **[→]** or **[▷]** key to display the number of masters and prints made under your user code.

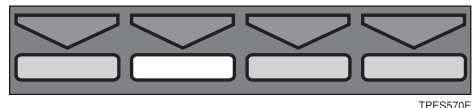
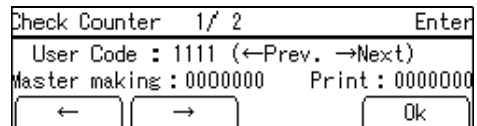

- 5** Press the **[OK]** key after checking the number of masters and prints made under your user code.

6-2 Reset Counters

1 Press the **[User Tools]** key.

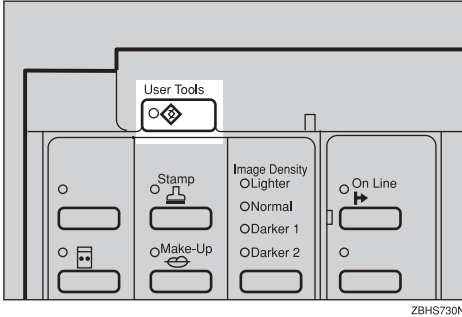

2 Enter 6 with the Number keys. Then press the **[OK]** or **[#]** key.

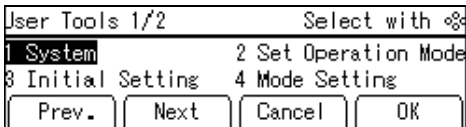

3 Enter 2 with the Number keys. Then press the **[OK]** or **[#]** key.

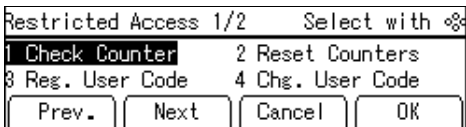

4 Select **[Single]** or **[All]** with the **[←]** **[→]** or **[◀]** **[▶]** keys.

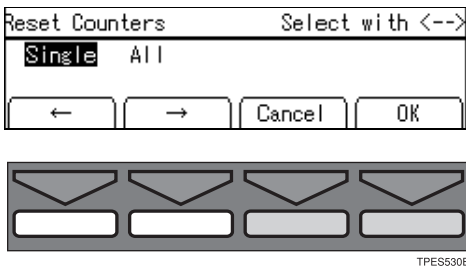

5 Press the **[OK]** key.

If you selected **[Single]**

1 Keep pressing the **[→]** or **[▶]** key to display the number of masters and prints made under your user code.

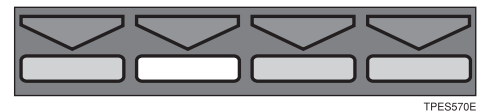
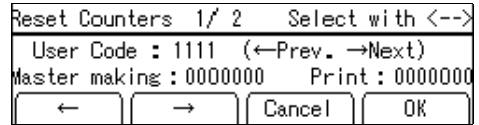

2 Press the **[OK]** key.

3 Press the **[Yes]** key.

4 Press the **[Cancel]** key twice.

If you selected **[All]**

1 Press the **[Yes]** key.

6-4 Chg. User Code

1 Press the **[User Tools]** key.

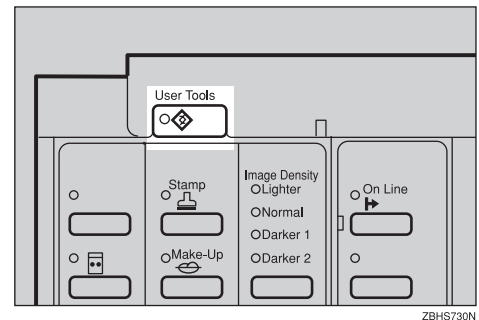

2 Enter 6 with the Number keys. Then press the **[OK]** or **[#]** key.

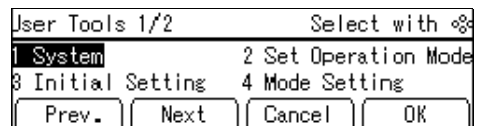

- 3** Enter 4 with the Number keys. Then press the [OK] or [#] key.

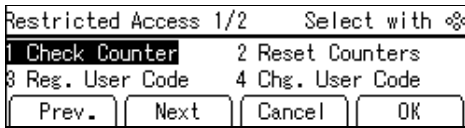

- 4** Keep pressing the [→] or [▷] key to display your user code.

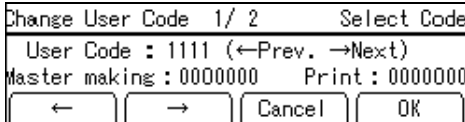

TPES570E

- 5** Press the [OK] key.

- 6** Enter the new user code with the Number keys.

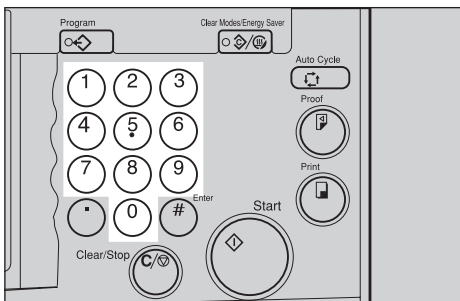

ZBHS310N

- 7** Press the [OK] key.

6-5 Del. User Code

- 1** Press the [User Tools] key.

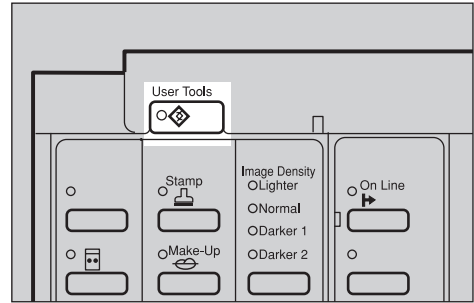

ZBHS730N

- 2** Enter 6 with the Number keys. Then press the [OK] or [#] key.

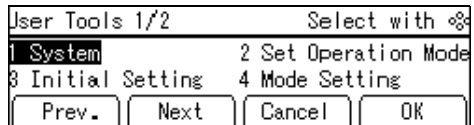

- 3** Enter 5 with the Number keys. Then press the [OK] or [#] key.

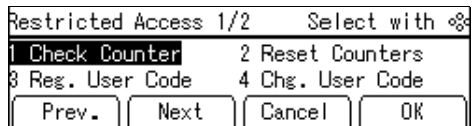

- 4** Keep pressing the [→] or [▷] key to display your user code.

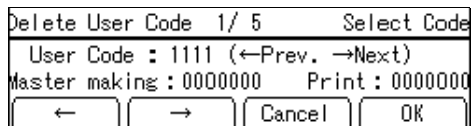

TPES570E

- 5** Press the [OK] key.





- 6** Press the [Yes] key.

5. What to do If Something Goes Wrong

If Your Machine does not Operate as You Want

If a malfunction or a misfeed occurs, the following messages will appear on the panel display.

Message	Meaning
Check the original direction.	The paper is not placed in the same direction as the original. Place the original in the same direction as the paper. If you press the 【Print】 key, the selected paper will be used for printing.
Size of original and paper is not the same.	Set a paper size that matches the reproduction ratio you have selected and your original. The reproduction ratio selected by Auto Magnification Selection mode is too big or too small.  Note <input type="checkbox"/> You can make prints if you press the 【Print】 key.
Set original.	Make prints after confirming whether there is an original on the exposure glass (contact glass). Make sure that you have changed the original on the exposure glass (contact glass) before pressing the 【Start】 key.
Max. quantity: ****	The number of prints exceeds the maximum print quantity. You can change the maximum number of prints that can be made in one operation with the user tools. See "Max. Quantity" ⇒ P.143 "2. Set Operation Mode".
Min. quantity: ****	The number of prints does not exceed the minimum print quantity. You can change the minimum number of prints that can be made in one operation with the user tools. See "Min. Quantity" ⇒ P.143 "2. Set Operation Mode".
Drum unit is not set. Set Drum unit.	Slide in the drum until it clicks. Make sure that the drum is completely set in position.
Communication error Turn the main switch off then on	Turn the main switch off and on. If the message appears again, contact your service representative.

Message	Meaning
<p>Papers are left on the delivery tray Please remove</p>	<p>Remove the paper from the delivery tray, or make the master and prints using the same paper as the previously used one.</p> <p> Note</p> <ul style="list-style-type: none"> <input type="checkbox"/> You can eliminate this message by pressing the [Exit] key. However, this message will be displayed again when making the master or prints if you do not remove the paper.
<p>Please put up side/end plates on the delivery tray</p>	<p>The paper delivery side or end plate is lowered. Lift the paper delivery side or end plate.</p> <p> Note</p> <ul style="list-style-type: none"> <input type="checkbox"/> If you press the [Exit] key to dismiss the message and press the [Start] key or [Print] key, the machine starts to make the master or prints. However, the prints might not be aligned.
<p>Over loaded for the delivery tray Please remove the paper</p>	<p>Remove the paper from the delivery tray.</p> <p> Reference</p> <p>See "Delivery Capacity" ⇒ P.143 "2. Set Operation Mode".</p>
<p>Print image is larger than the selected paper size. Change the paper size.</p>	<p>The master image previously printed is larger than the paper, the image overflows the paper size. Make prints again after pressing the [Exit] key and selecting the paper size again.</p> <p> Note</p> <ul style="list-style-type: none"> <input type="checkbox"/> If you press the [Exit] key to dismiss the message and press the [Print] key, the machine starts to make the prints. However, the image might not fit on the paper.
<p>Cannot sort thick papers</p>	<p>The paper type is set as the "Thick" or "Special". Press the [Exit] key to dismiss the message and select the paper type except Thick and Special. If you cannot change the paper type, press the [Exit] key to dismiss the message and disable sorter mode.</p> <p> Note</p> <ul style="list-style-type: none"> <input type="checkbox"/> If you press the [Exit] the message will be dismissed, but it will be displayed again when making the master or prints.

Message	Meaning
Cannot sort irregular sized papers.	<p>The custom size is selected.</p> <p>Press the [Exit] key to dismiss the message and use paper other than the custom size.</p> <p>If you cannot change the paper type, press the [Exit] key to dismiss the message and disable sorter mode.</p> <p> Note</p> <p><input type="checkbox"/> If you press the [Exit] key the message will be dismissed but it will be displayed again when making the master or prints.</p>
Non-sort tray is not set correctly	Slide in the delivery tray of the sorter correctly.
Sorter is full. Please remove the paper	The number of prints exceeds the capacity of the bin. Remove the paper from the sorter.
Papers are left on the sort tray. Please remove.	Remove the paper from the sorter tray.
Switch on the sorter Or communication error.	<p>If the sorter power plug is pulled out, plug it in and turn it on.</p> <p>If the message appears again, there was an error connecting to the sorter.</p> <p>Contact your local representative.</p>

When a service call message is shown on the panel display panel

Press the **[Exit]** key. Then turn the main switch off and back on again. If a service code appears again, contact your service representative.

Note

- If a service code appears on the panel display after you turn the main switch off and on a few times, do not continue turning it on and off. Leave the machine off.
- When you make masters continuously using originals with solid images, "SC-03-03" tends to appear on the panel display. In this case, turn off the main switch and wait for a while. Then turn on the main switch.

If You Cannot Make Prints as You Want

Problem	Cause	Action
Misfeeds occur frequently.	Improper paper type is selected.	Select proper paper type. See ⇒ P.42 "Printing onto Various Kinds of Paper".
When you try to set several functions at a time, you cannot set some functions.	Some functions cannot be used together.	See ⇒ P.137 "Combination Chart".
Parts of the image are not printed in Edge Erase mode.	Erase margin is too wide.	Set a narrower erase margin with the user tools. See ⇒ P.158 "3-9 Margin Erase Area".
	Edge margins of original are too narrow.	
Prints are blank or parts of the image are not printed.	The paper feed side plates are not set correctly.	Make sure that the paper feed side plates touch the paper lightly and the proper paper size is displayed in the panel display.

5

Combine Originals Mode

Problem	Cause	Action
Prints are blank or parts of the image are not printed.	Original size and direction are not correct.	You cannot use originals of different sizes and directions in Combine Originals mode. Use originals of same size and direction.
Print image is not correct.	Original set order is not correct.	Set originals face up into the optional document feeder. The first original should be on the top.
		Set original face down on the exposure glass (contact glass). The first original should be set first.

Loading Paper

The **Load Paper** indicator (🖨️) lights when the paper feed tray runs out of paper.

⚠️ Limitation

- ❑ Load paper when the paper feed tray is empty. Do not add paper when some paper is left in the tray. Doing so may cause problems, such as multiple feeds and mis-feeds.
- ❑ If paper runs out when using the "Limitless Feeding" function, first load paper in the last tray that was used or the **Load Paper** indicator (🖨️) will not turn off.

🔍 Reference

For available paper sizes, see ⇒ P.11 "Print Paper".

- 1** Load the paper in the Paper feed tray.

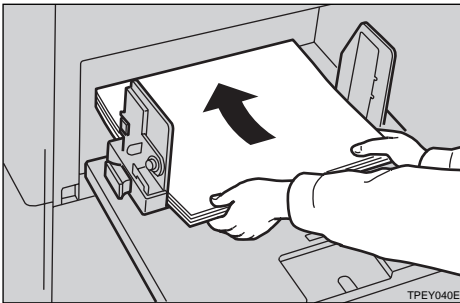

📌 Note

- ❑ Correct any paper curl before loading the paper.

- 2** Adjust the paper feed side plate to match the paper size.

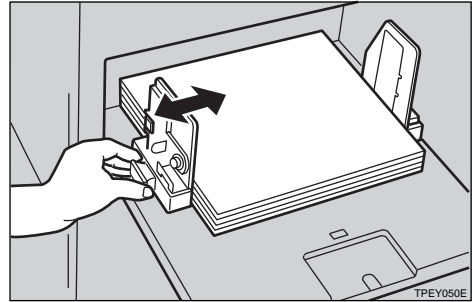

📌 Note

- ❑ Make sure that the paper size and direction shown on the panel display match the size and direction actually loaded in the Paper feed tray.

Clearing Misfeeds

CAUTION:



• Be careful not to cut yourself on any sharp edges when you reach inside the machine to remove misfed sheets of paper or masters.

Note

- ❑ After clearing misfeeds, make sure that all the doors, covers, and units are closed and the indicator is off.
- ❑ To prevent misfeeds, do not leave any torn scraps of paper, originals, or masters in the machine.
- ❑ When clearing misfeeds, do not turn off the main switch. If you do, your print settings will be cleared.
- ❑ If misfeeds occur repeatedly, please contact your service representative.

"A" Paper Misfeed in the Paper Feed Section

1 Remove the misfed paper.

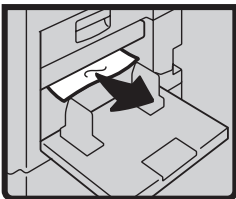

To prevent paper misfeeds:

Check the following before restarting the printing run.

- Did you select an appropriate paper type with the [Ppr.Type] key?



TPESS20E

- Are the side pads in the correct positions?

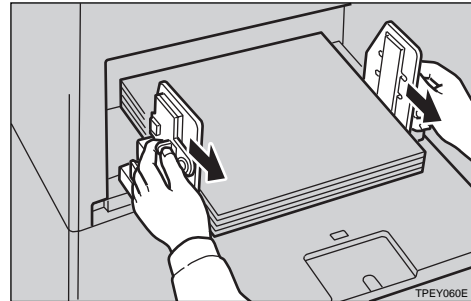

TPEY060E

To print on thin paper (47.1g/m², 12.5 lb), slide the levers behind the paper feed side plates in the direction of the arrow (see illustration).

- When paper is curled, correct the curl as shown.

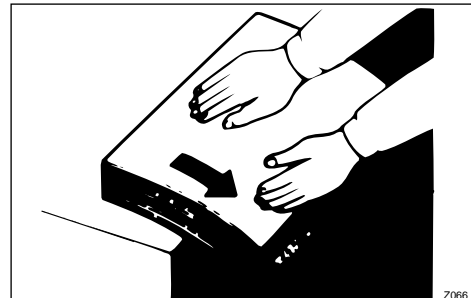

Z066

- When paper edges stick together or paper is not fed in, shuffle the paper as shown.

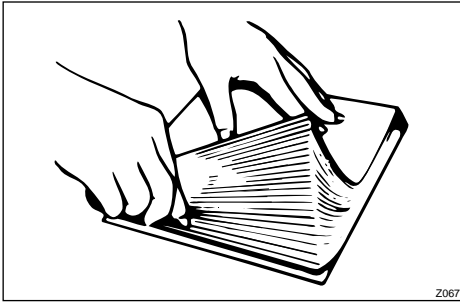

- When printing onto postcards or thick paper, lower the printing speed to setting 1 or 2. See ⇒ P.27 "Changing the Printing Speed".

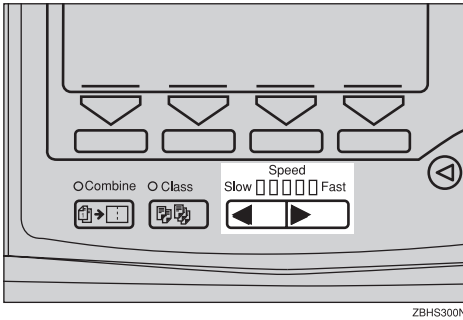

- When a multi-feed occurs or the paper is skewed, make sure that the paper feed side plates are properly adjusted. When you load paper on the Paper feed tray, make sure that the paper edge touches the back fence and paper is placed on the proper paper size scale. Only use paper where the leading edge has two right angle corners.

"A + B" Paper Misfeed in the Paper Feed Section

- 1 Open the front door.
- 2 Lower drum unit lock lever B1.

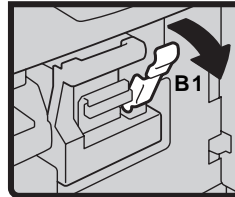

- 3 Take out the drum.

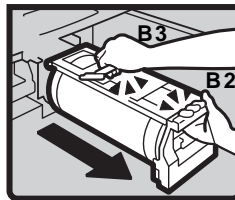
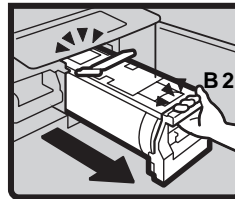

Note

- For how to take out the drum unit, see ⇒ P.86 "Changing the Colour Drum Unit".

- 4 Pull out the misfed paper gently from the inside.

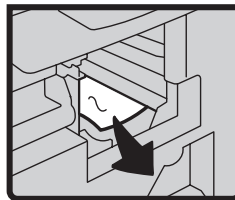

- 5** If you cannot remove the misfed paper, remove paper from the Paper feed tray.

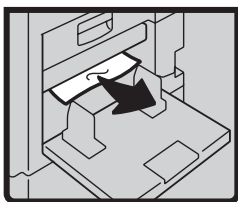

- 6** Set the drum unit and close the front door.

To prevent paper misfeeds:

See ⇒ P.178 ““x + A” Paper Misfed in the Paper Feed Section”.

“x + B” Paper or Master Wrapped around the Drum

When the master is wrapped around the drum

- 1** Open the front door.
2 Lower drum unit lock lever B1.

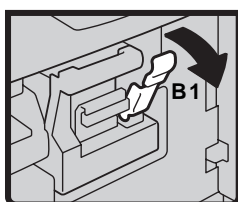

- 3** Take out the drum.

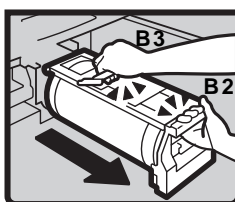
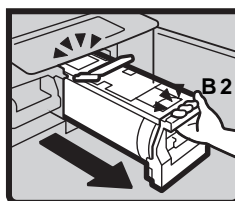

Note

- For how to take out the drum unit, see ⇒ P.86 “Changing the Colour Drum Unit”.

- 4** While pressing the drum lock, grasp the edge of the master (the white area) and peel it off.

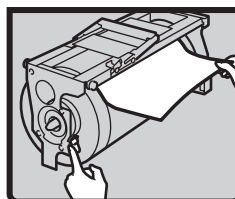

- 5** Return the drum lock to its original position.
6 Set the drum unit and close the front door.

When paper is wrapped around the drum

- 1** Open the front cover.
- 2** Lower drum unit lock lever B1.

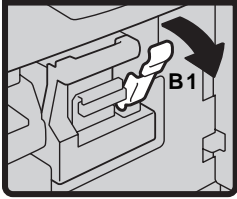

- 3** Take out the drum.

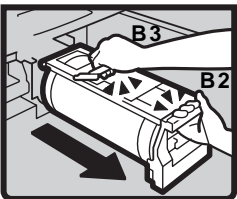
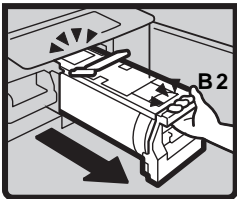

Note

- For how to take out the drum unit, see ⇒ P.86 "Changing the Colour Drum Unit".

- 4** Remove the misfed paper from the drum.

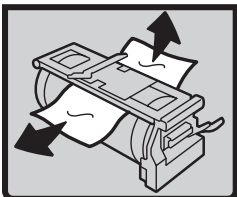

- 5** If you cannot find misfed paper in step 4, remove misfed paper from the pressure cylinder.

- 6** Set the drum unit and close the front door.

When paper is misfed inside the machine

- 1** Open the front cover.
- 2** Lower drum unit lock lever B1.

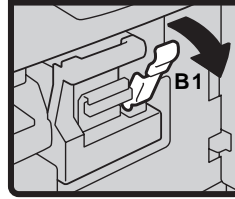

- 3** Take out the drum.

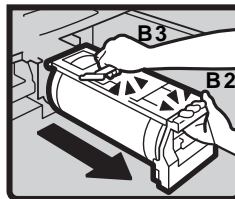
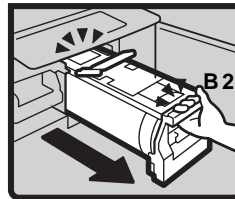

Note

- For how to take out the drum unit, see ⇒ P.86 "Changing the Colour Drum Unit".

- 4** Remove the misfed paper from the inside as shown in the illustration.

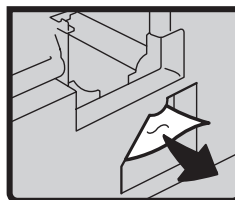

- 5** If you cannot remove the misfed paper, remove paper from the pressure cylinder.

- 6** Set the drum unit and close the front door.

To prevent paper misfeeds:

If the paper is curled or the original's leading edge margin is too narrow, the following action is necessary.

- When you use curled paper, correct the curl as shown.

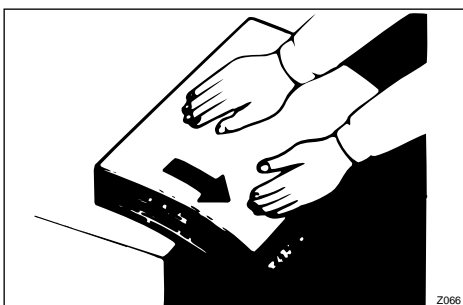

- When the leading edge margin of the original is less than 10mm, 0.4" or there is a solid image on the leading edge, insert the original with the widest margin first or make a leading edge margin by making a copy.

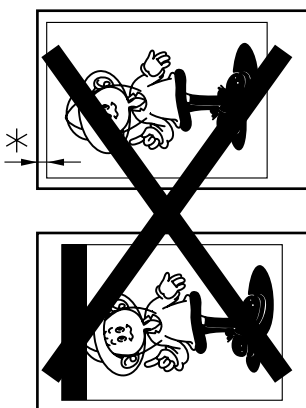

*: Less than 10mm, 0.4"

5

"⌘ + C" Paper Misfeed in the Paper Exit Section

- 1 Slowly but firmly pull out the misfed paper.

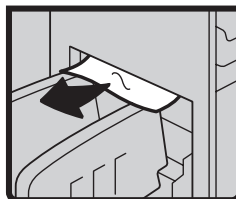

To prevent paper misfeeds:

When a thin paper misfeed in the paper exit section occurs, reduce the printing speed with the [◀][▶] [Speed] keys (See ⇒ P.27 "Changing the Printing Speed"). If you cannot reduce the printing speed, close the trailing edge guides or move the end plate toward the paper delivery tray edge.

"⌘ + D" Master Misfeed in the Master Feed Section

- 1 Pull out the master tray until it stops.
- 2 Open the master guide.

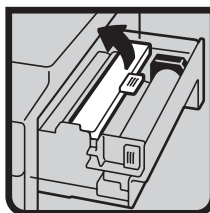

- 3 Open the master tray cover (1).

- 4** Remove the master roll (2).

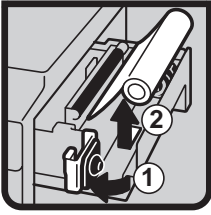

- 5** Reset the master roll (1).

Note

- The master roll must be positioned as shown in the illustration in step **6**.

- 6** Close the master tray cover (2).

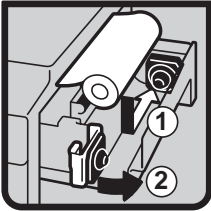

- 7** Insert the paper edge of the master roll as shown in the illustration until the master edge reaches the arrow mark.

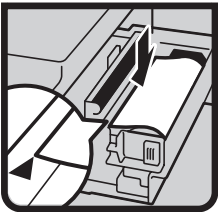

- 8** Close the master guide.

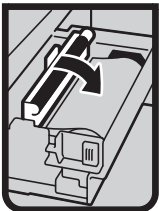

- 9** Push in the master tray until it stops.

"R + D + B" Master Misfeed in the Master Feed Section

- 1** Open the front door.
2 Lower drum unit look lever B1.

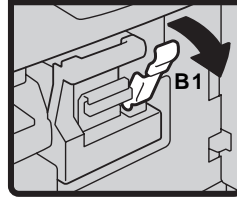

- 3** Take out the drum.

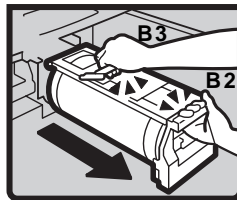
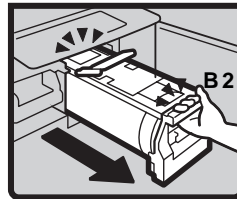

Note

- For how to take out the drum unit, see ⇒ P.86 "Changing the Colour Drum Unit".

- 4** Pull out the misfed master from inside.

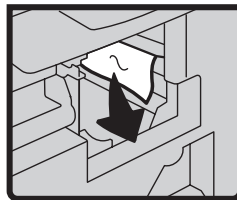

- 5** Set the drum unit and close the front door.

" + B + E" Master Misfeed in the Master Eject Section

- 1 Open the front door.
- 2 Lower drum unit lock lever B1.

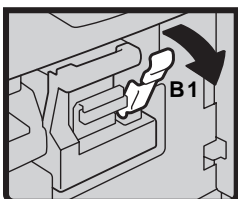

- 3 Take out the drum.

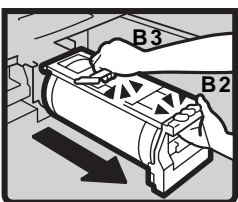
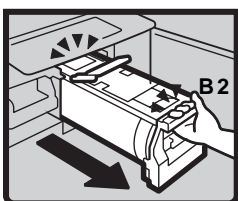

Note

- For how to take out the drum unit, see ⇒ P.86 "Changing the Colour Drum Unit".

- 4 Grasp handle E1 and pull out the master eject unit until it stops.

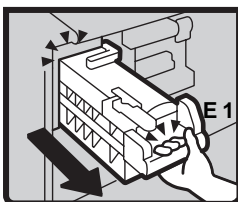

- 5 Pull out lever E3 and remove the misfed master.

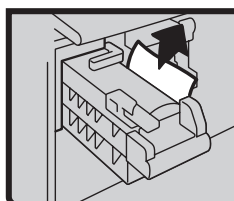
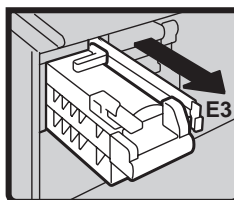

- 6 Return lever E3 and the master eject unit to their original position.
- 7 Set the drum unit and close the front door.

" + E" Master Misfeed in the Master Eject Section

- 1 Open the front door.
- 2 Grasp handle E1 and pull out the master eject unit until it stops.

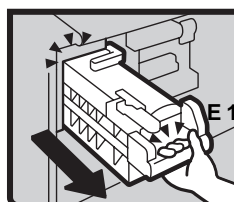

- 3 Check where the misfed master is. Remove the misfed master.

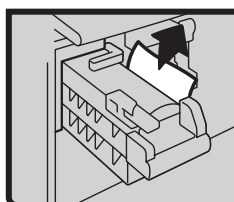

- Return the master eject unit to its original position and close the front door.

💡 If master misfeeds often occur

If the master misfeed occurs so often, turn scraps of the master might be left in the bottom of the master tray. Remove turn scraps of the master.

- Slide out the master tray.

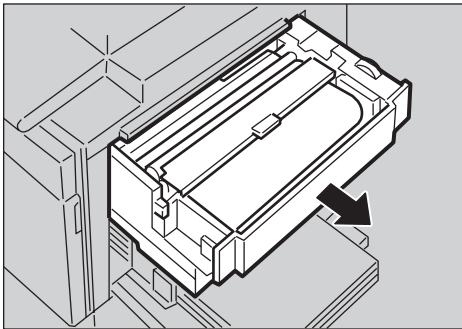

ZADH180E

- Open the black cover at the bottom of the master tray and remove turn scraps of the master.

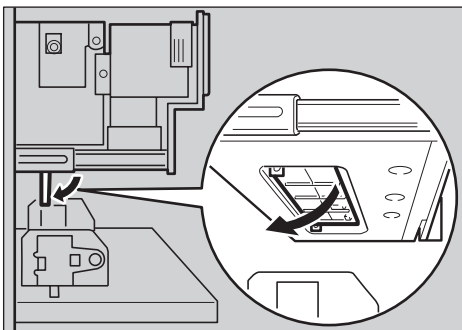

ZADH210E

- Close the black cover and slide in the master tray.

Note

- Make sure that you securely close the black cover before sliding in the master tray.

”Ⓜ + P” Original Misfeed Occurs When Using the Optional Document Feeder

- Open the document feeder (ADF) cover.

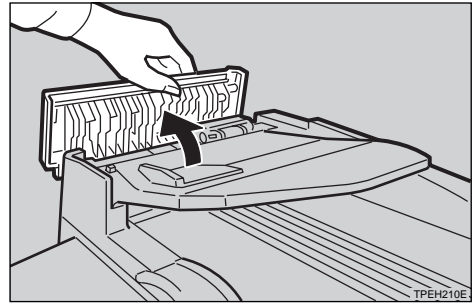

TPEH210E

- Pull out the misfed original gently.

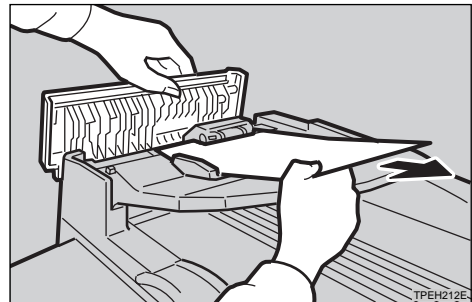

TPEH212E

- If you cannot remove misfed original in step 2, open the document feeder.

- Pull the green knob towards you and remove the misfed original.

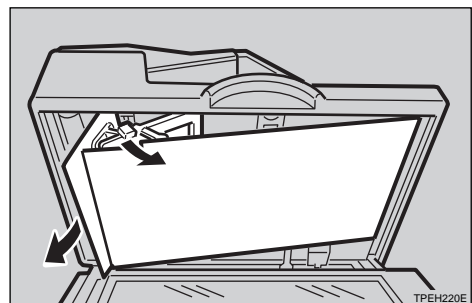

TPEH220E

5 Return the document feed sheet to its original position.

6 Close the document feeder (ADF) cover until it clicks in position and if necessary, close the document feeder.

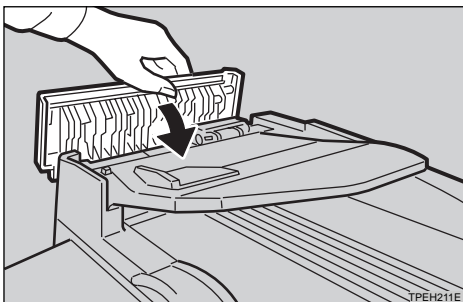

5

To prevent original misfeeds:

Set the following kinds of originals on the exposure glass (contact glass).

- Originals heavier than 105g/m², 27 lb
- Originals lighter than 52g/m², 14 lb
- Originals smaller than 105mm × 128mm, 4.2" × 5.1"
- Originals larger than 297mm × 864mm, 11.6" × 34.0"
- Stapled or clipped originals
- Perforated or torn originals
- Curled, folded, or creased originals
- Originals with any kind of coating, such as thermal fax paper, art paper, aluminum foil, carbon paper, or conductive paper
- Bound originals such as books
- Damaged originals
- Originals with glue on them
- Pasted originals
- Originals written in pencil
- Thin originals that have low stiffness

- Originals with index tabs
- Transparent originals such as OHP transparencies or translucent paper

Note

- Do not mix different sizes of originals in the optional document feeder.
- Remove staples or clips of originals. Fan originals that have had staples or clip removed.
- Do not stack originals above the limit mark.

"R1" Paper Misfeed in the Optional Sorter

1 Open the front cover.

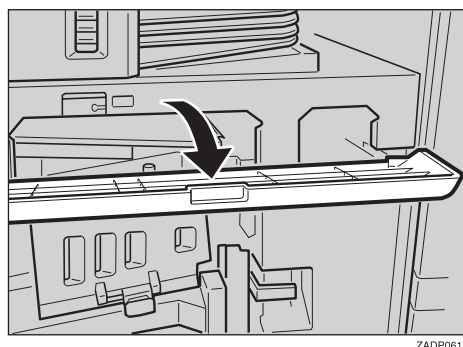

2 Remove the misfed paper.

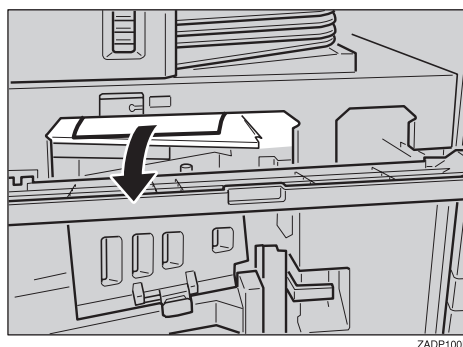

3 Close the front cover.

”8 1/2” + R2” Paper Misfeed in the Optional Sorter

- 1 Open the upper and lower side covers and check if there is a misfed paper.

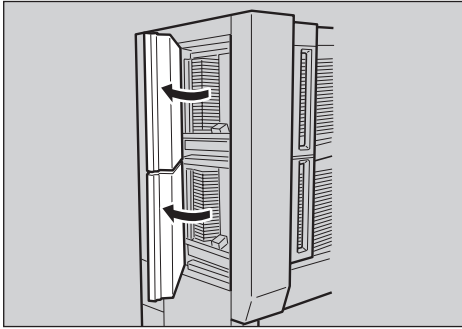

ZADP051E

- 2 Remove the misfed paper.

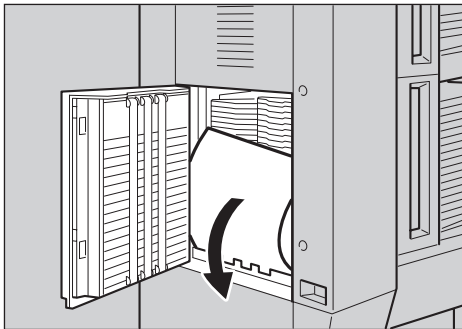

ZADP110E

Note

- The illustration describes how to remove misfed paper from the lower tray. Follow the same procedure for removing misfeeds in the upper tray.

- 3 Close the upper and lower side covers.

”8 1/2” + R3” ”8 1/2” + R4” Paper Misfeed in the Optional Sorter

- 1 When R3 is displayed, open the lower tray cover of the sorter. When R4 is displayed, open the upper tray cover of the sorter.

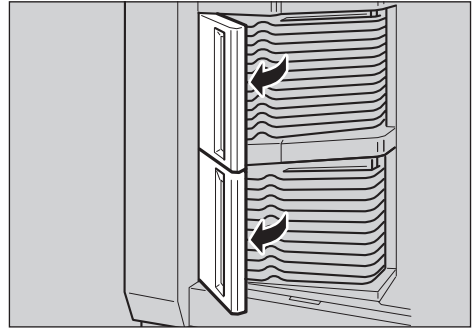

ZADP041E

- 2 If the misfed paper is deep inside of the bin and you cannot remove it, press the green button ② while pressing the button ①. When the misfed paper is pushed out, remove it from the sorter.

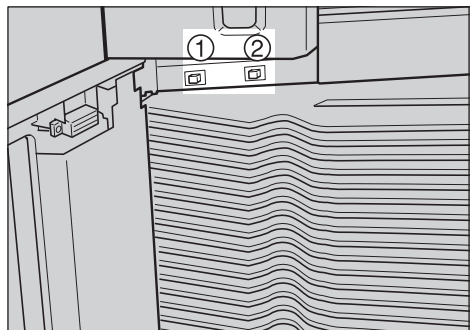

ZADP130E

- 3 Close the upper or lower tray cover.

When the Open Cover/Unit Indicator () Lights

Make sure that the following doors/covers are closed.

❖ Front door

Close the front door completely.

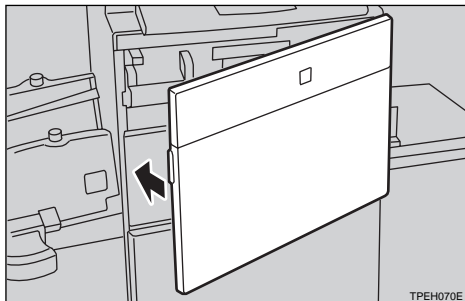

❖ Lower tray cover of the optional sorter

Close the lower tray cover of the sorter.

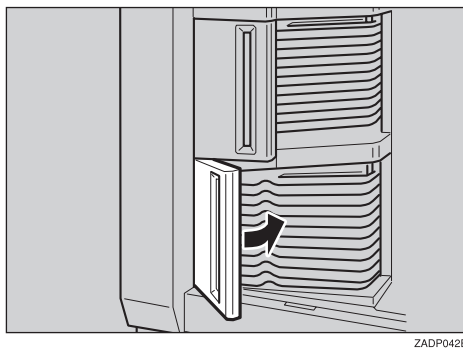

❖ Optional document feeder (ADF) cover

Close the document feeder (ADF) cover until it locks in position.

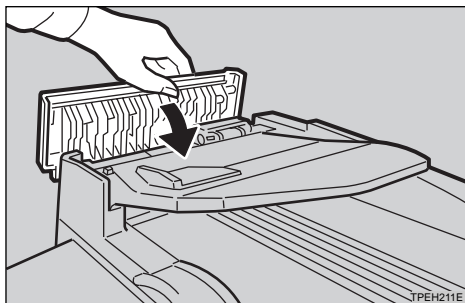

❖ Upper and lower covers of the optional sorter

Close the upper and lower covers of the sorter.

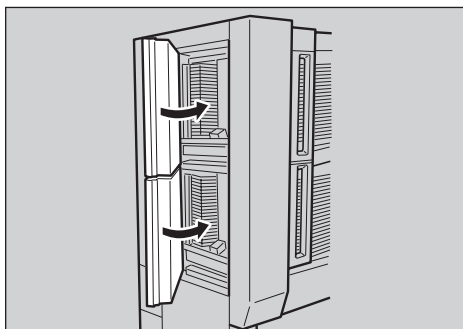

❖ Upper tray cover of the optional sorter

Close the upper tray cover of the sorter.

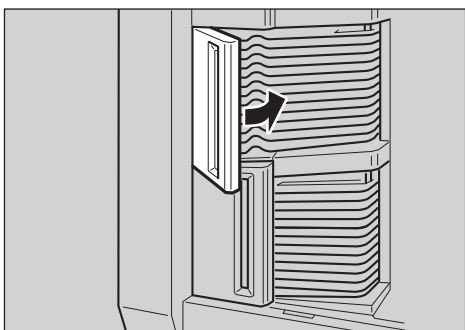

❖ Front cover of the optional sorter

Close the front cover of the sorter.

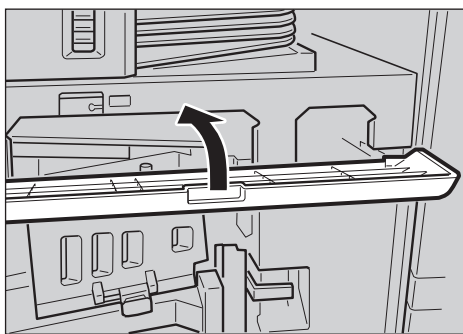

When the Add Ink Indicator (🖨️) Lights

The **Add Ink** indicator (🖨️) lights when it is time to supply ink.

⚠️ CAUTION:

- *If ink comes into contact with your eyes, rinse immediately in running water. In the case of any abnormal symptoms, consult a doctor.*

⚠️ CAUTION:

- *Keep the ink or ink container out of the reach of children.*

⚠️ CAUTION:

- *If ink is ingested, force vomiting by drinking a strong saline solution and consult a doctor immediately.*

⚠️ CAUTION:

- *Our products are engineered to meet high standards of quality and functionality, and we recommend that you only use the expendable supplies available at an authorized dealer.*

📝 Note

- Be sure to supply ink of the same colour as the current drum.
- Ink is readily removed from skin by waterless hand cleaners followed by washing with soap and water.
- Be careful not to get any ink on your clothing.
- Store ink under low temperature and humidity conditions.
- Do not store ink where it will be exposed to heat or direct sunlight.
- Store on a flat surface.

1 Open the front door.

2 Pull out the ink holder.

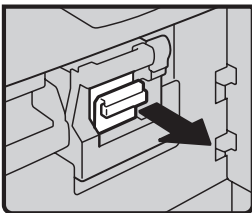

3 Remove the used ink cartridge.

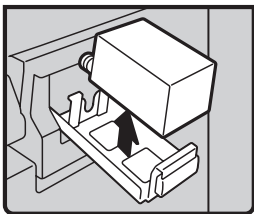

4 Remove the cap of the new ink cartridge.

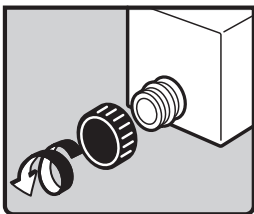

5

5 Insert the new cartridge into the ink holder.

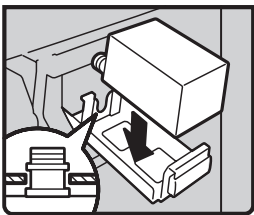

 **Note**

- Always supply ink of the same colour.

6 Return the ink holder to its original position until it clicks.

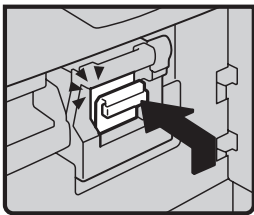

7 Close the front door.

The machine will start idling to supply ink to the drum.

When the Master End Indicator (📏) Lights

The **Master End** indicator (📏) lights when it is time to replace the master roll or when you need to set the master roll.

⚠ CAUTION:

- *Our products are engineered to meet high standards of quality and functionality, and we recommend that you only use the expendable supplies available at an authorized dealer.*

1 Pull out the master feed unit until it stops.

2 Open the master guide.



3 Open the master feed unit cover (1).

4 Remove the used master roll (2).

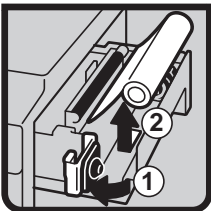

Note

- When the **Master End** indicator is lit, it is necessary to replace the master roll even if some master remains on the old roll.

5 The new master roll must be positioned as shown in the illustration (1).

6 Close the master feed unit cover (2).

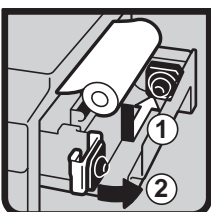

- 7** Insert the paper edge of the master roll as shown in the illustration until the master edge reaches the arrow mark.

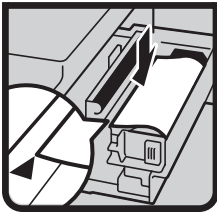

- 8** Close the master guide.

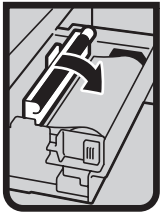

5

- 9** Push in the master feed unit until it stops.

When the Master Eject Indicator (🗑️) Lights

The **Master Eject** indicator (🗑️) lights when it is time to empty the master eject unit or when you need to set the master eject unit.

🔧 Note

- ❑ Ink is readily removed from skin by waterless hand cleaners followed by washing with soap and water.
- ❑ Be careful not to get any ink on your clothing while emptying the master eject unit.

- 1** Prepare the trash box.
- 2** Open the front door.
- 3** Grasp handle E1 and pull out the master eject unit until it stops.

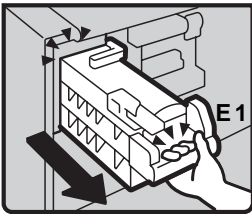

- 4** Pull up handle E2 and pull out the master eject unit completely.

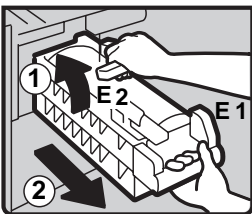

- 5** Grasp the master eject unit upper handle and turn it clockwise with one hand while holding handle E1 with other hand (1).

- 6** Remove the used master by pushing down the master eject unit upper handle towards the trash box (2).

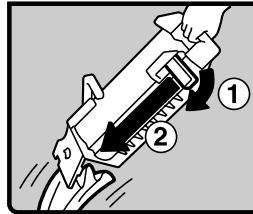







🔧 Note

- ❑ If you cannot remove the used masters completely, repeat step **6** until all the masters are removed.

- 7** Reinstall the master eject unit until it clicks in position.
- 8** Close the front cover.

When Other Indicators are Lit

Indicator	Meaning and action
 <p>TPES270E</p>	<p>The key counter (option) is not set. Insert the key counter.</p>
<ul style="list-style-type: none"> • (Metric version)  <p>TPES280E</p> • (Inch version)  <p>TPES280N</p> 	<p>colour drum unit is installed.</p>
<ul style="list-style-type: none"> • (Metric version)  <p>TPES290E</p> • (Inch version)  <p>TPES290N</p> 	<p>A3/11" × 17" drum unit is set.</p>
<ul style="list-style-type: none"> • (Metric version)  <p>TPES300E</p> • (Inch version)  <p>TPES300N</p> 	<p>A4/8¹/₂" × 11" drum unit is set.</p>

When Prints are not Delivered in a Neat Stack

When Printing on Small Size Paper

- 1 Lower the paper delivery end plate a little. While holding the end plate, lift the angle adjustment screw.

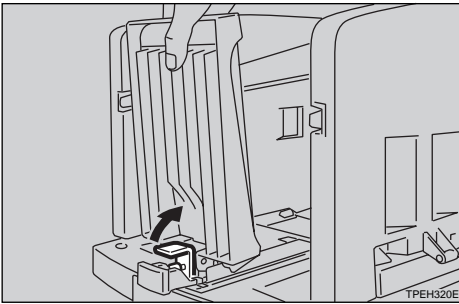

- 2 Adjust the end plate angle by turning the screw clockwise or counterclockwise.

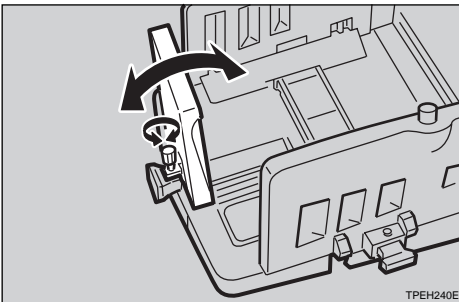

When the Machine Cannot Detect the Paper Size

If the paper size is not detected correctly when printing with the sorter, prints might not be delivered in a neat stack. To solve this, do one of the following:

- 1 Re-adjust the paper feed side plate so that there is no space between the paper feed side plate and paper.

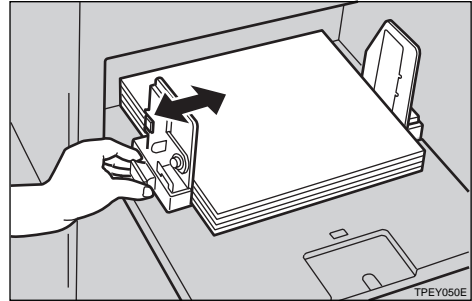

Note

- Make sure that the paper size and direction in the panel display panel correspond with the actual paper size and direction set on the paper feed tray.
- If the paper on the Paper feed tray has a solid image on its back side, the machine may not be able to detect the size correctly. Place a sheet of paper of the same size without an image on the back at the bottom of the paper stack.

Poor Printing

Dirty Background

If the background of prints is dirty, the drum unit is dirty.

⚠ CAUTION:

- *If ink comes into contact with your eyes, rinse immediately in running water. In the case of any abnormal symptoms, consult a doctor.*

⚠ CAUTION:

- *Keep the ink or ink container out of the reach of children.*

⚠ CAUTION:

- *If ink is ingested, force vomiting by drinking a strong saline solution and consult a doctor immediately.*

5

📌 Note

- ❑ To avoid getting dirty background prints when printing onto paper smaller than the original image, select a suitable reduction ratio or use larger print paper.
- ❑ When printing onto paper that does not absorb ink well, like postcards, the background of prints might get dirty. In this case, lower the printing speed or use Skip Feed mode to dry the ink on the prints.

1 Turn off the main switch.

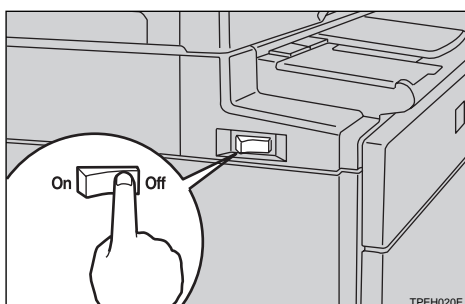

2 Pull out the drum unit.

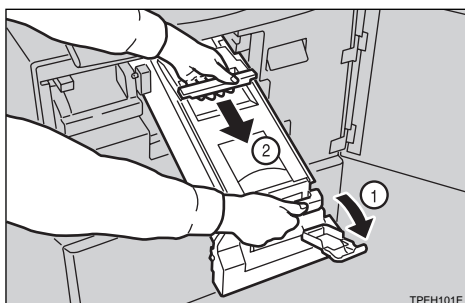

 **Note**

- For how to take out the drum unit, see ⇒ P.86 “Changing the Colour Drum Unit”.

- 3** While pressing the drum lock, turn the drum until you can see the trailing edge of the master.

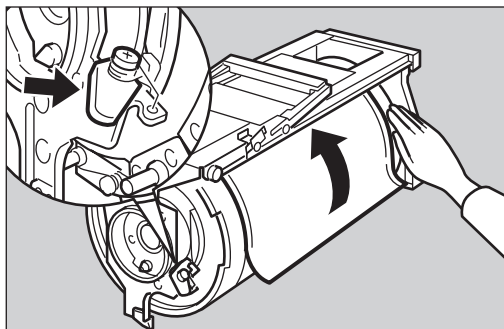

ZBHH100E

- 4** With a dry soft cloth, remove any ink that has accumulated on the trailing edge of the drum unit.

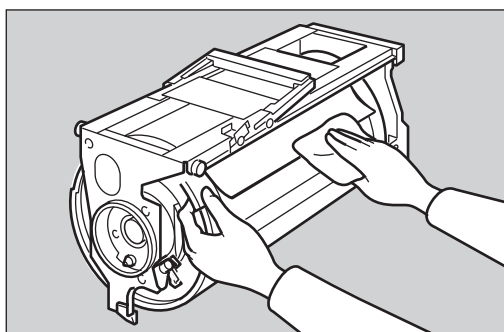

ZBHH210E

 **Important**

- Do not use benzine, thinner, or other organic liquids—doing so can damage the machine.

- 5** Turn the drum unit and lock it after cleaning it.

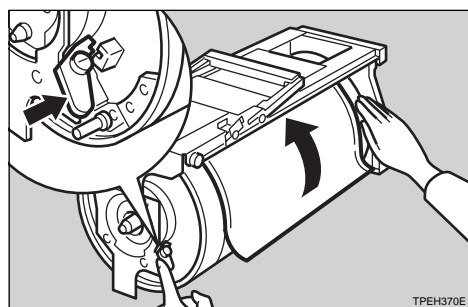

TPEH370E

- 6** Insert the drum unit until it locks in position, then lower the drum unit lock lever.

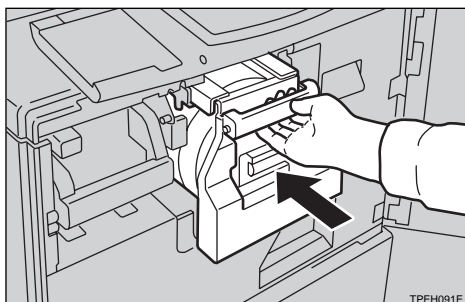

- 7** Close the front door.

- 8** Turn on the main switch.

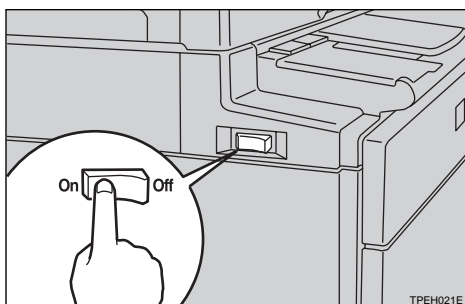

5

Black Lines/Stained Prints

Check the platen cover and clean it if dirty. See ⇒ P.204 “*Cleaning the platen cover*”.

Check the exposure glass (contact glass) and clean it if dirty. See ⇒ P.204 “*Cleaning the exposure glass (contact glass)*”.

Check the sheet of the optional document feeder and clean it if dirty. See ⇒ P.205 “*Cleaning the Sheet*”.

 **Note**

- When black lines or stains still appear on prints even if you clean the above, please contact your service representative.

Faint Prints

If the machine is not used for a long period of time or you change the colour drum unit, the ink on the drum might dry causing print quality to deteriorate. To solve this problem, use Quality Start Mode. See ⇒ P.75 “*Quality Start Mode—Regaining Image Density When Drum Ink Dries*”.

If the print density is still too light even if you use Quality Start mode, remake the master.

Do's and Don'ts

CAUTION:

- *Unplug the power cord from the wall outlet before you move the equipment. While moving the equipment, you should take care that the power cord will not be damaged under the equipment.*

Important

- Make sure that  indicator on the PC controller operation panel is off before unplugging the power cord.
- While printing, do not turn off the main switch.
- While printing, do not unplug the power cord.
- While printing, do not open the door or covers.
- While printing, do not move the machine.
- Open and close the door and covers softly.
- When printing onto paper that contains images on the back, make sure there is a 10mm (0.4") margin at the back leading edge. If there is no margin, the machine might wrongly detect that paper is wrapped around the drum and stop printing.
- When you use envelope or pasted print paper, the leading edge of print might be damaged.
- Make sure to make a few trial prints to check the image position because the image position of the trial print might not correspond with that of the original.
- The leading edge of the prints might become stained if the edge touches the image of prints on the paper delivery tray.
- Print ink on the paper delivery tray might stick to the back side of the next print.
- Press the **[Proof]** key to perform a test print as the image density of the first few prints might be light.
- When the machine is on and the power source is less than 90% of the specified amount, printing quality will decrease. Therefore, make sure the supply from your electrical outlet is at least 90% of the required amount.
- When printing a large solid area on A3, 11" x 17" paper, the sides of the print tend to curl up after the print is fed out to the paper delivery tray. The next sheet that feeds out pushes against the curled sheet and a paper misfeed occurs. In this case, slow the printing speed down (setting 1 or 2).

- When you make a lot of prints from a small image, ink might ooze out from the edges of the master, especially under high temperature and when printing in two or more colours. In this case, make a new master.
- Remove the paper from the tray before relocating the machine. If you relocate the machine leaving the paper on the tray, reset the paper after the relocation. If the main switch of the machine is turned on without resetting the paper correctly, the sensor might be broken.

Where to Put Your Machine

Environment

Your machine's location should be carefully chosen because environmental conditions greatly affect its performance.

Optimum environmental conditions

⚠ CAUTION:

- *Keep the equipment away from humidity and dust. Otherwise a fire or an electric shock might occur.*
- *Do not place the equipment on an unstable or tilted surface. If it topples over, it could cause injury.*

⚠ CAUTION:

- *If you use the equipment in a confined space, make sure there is a continuous air turnover.*

⚠ CAUTION:

- *After you move the equipment, use the caster fixture to fix it in place. Otherwise the equipment might move or come down to cause a personal injury.*

- Temperature: 10 – 30°C, 50 – 86°F
- Humidity: 20 – 90% RH
- A strong and level base (a sturdy desk and cabinet etc.).
- The machine must be level within 5mm, 0.2" both front to rear and left to right.
- Be sure to locate this machine in a large well ventilated room that has an air turnover of more than 30m³/hr/person.

Environments to avoid

- Locations exposed to direct sunlight or strong light (more than 1500 lux).
- Locations directly exposed to cool air from an air conditioner or heated air from a heater (sudden temperature changes might cause condensation within the machine).
- Places where the machine might be subjected to frequent strong vibration.
- Dusty areas.
- Areas with corrosive gases.

Power Connection

⚠ WARNING:

- **Only connect the machine to the power source described on the inside front cover of this manual. Connect the power cord directly into a wall outlet and do not use an extension cord.**
- **Do not damage, break or make any modifications to the power cord. Do not place heavy objects on it. Do not pull it hard nor bend it more than necessary. These actions could cause an electric shock or fire.**

⚠ CAUTION:

- *Unplug the power cord from the wall outlet before you move the equipment. While moving the equipment, you should take care that the power cord will not be damaged under the equipment.*

⚠ CAUTION:

- *When you disconnect the power plug from the wall outlet, always pull the plug (not the cable).*

Make sure the plug is firmly inserted in the outlet.

6

Machine Clearance

Place the machine near the power source, providing clearance as shown.

❖ **Main frame**

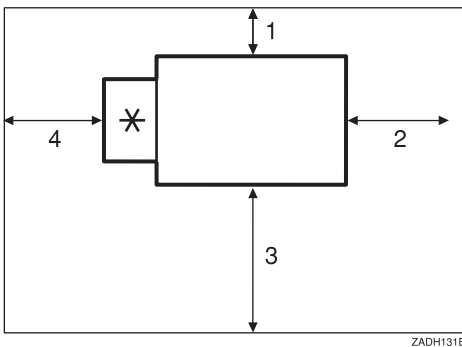

*: Paper delivery tray

1. More than 10cm, 4.0"
2. More than 60cm, 23.7"
3. More than 60cm, 23.7"
4. More than 60cm, 23.7"

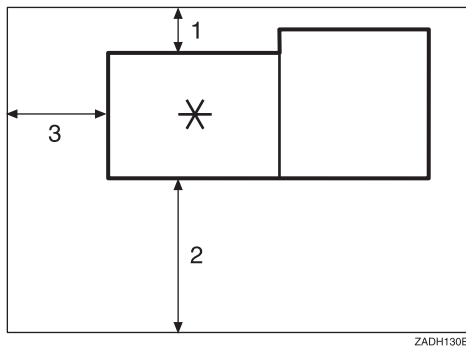
❖ Main frame with the optional sorter

*: Optional sorter

1. More than 20cm, 8.0"
2. More than 100cm, 40.0"
3. More than 60cm, 23.7"

Maintaining Your Machine

To maintain high print quality, clean the following parts and units regularly.

❖ Cleaning the machine

Wipe the machine with a soft, damp cloth. Then wipe it with a dry cloth to remove the water.

⚠ Important

- Do not use chemical cleaner or organic solvent, such as thinner or benzene. If they get into the machine or melt plastic parts, a failure might occur.
- Do not clean parts other than those specified in this manual. Such parts should be cleaned by your service representative.

Cleaning the Main Frame

Cleaning the exposure glass (contact glass)

1 Lift the platen cover or document feeder.

2 Clean ① and ②.

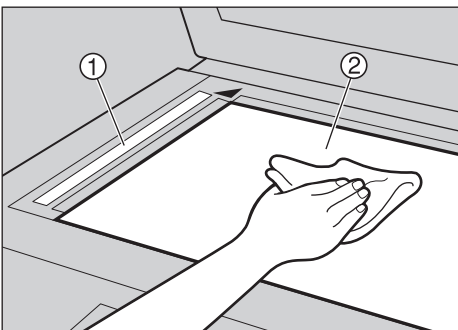

ZADH140E

Cleaning the platen cover

1 Lift the platen cover.

2 Clean the platen cover with a damp cloth and wipe it with a dry cloth.

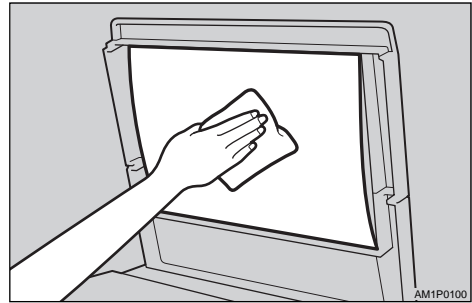

AM1P0100

✎ Note

- If you do not clean the platen cover, marks on the cover will be printed.

Cleaning the paper feed roller (Paper feed tray)

1 Wipe off the paper dust on the paper feed roller with a damp cloth, then wipe it with a dry cloth.

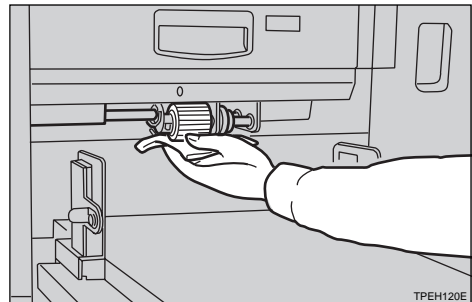

TPEH120E

✎ Note

- If you do not clean the paper feed roller, paper misfeeds tend to occur.

Cleaning the Optional Document Feeder

Cleaning the Sheet

- 1** Lift the document feeder.
- 2** Clean the sheet with a damp cloth and wipe it with a dry cloth.

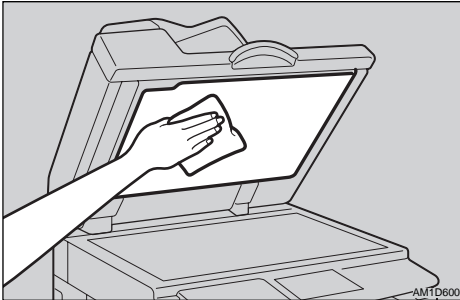

 **Note**

- If you do not clean the sheet, marks on the sheet will be printed.

7. Specifications

Main Frame

- ❖ **Configuration:**
Desk top
- ❖ **Printing Process:**
Full automatic one drum system
- ❖ **Original Type:**
Sheet/Book
- ❖ **Original Size:**
Maximum 304.8mm × 432mm, 12.0" × 17.0"
- ❖ **Pixel Density:**
400dpi
- ❖ **Image Mode:**
Photo mode (Sand pattern)
Letter mode (Standard mode)
Letter/Photo mode
Pencil mode
Tint mode
- ❖ **Reduction Ratios:**
 - Inch version:
93%, 77%, 74%, 65%
 - Metric version:
93%, 87%, 82%, 71%
- ❖ **Enlargement Ratios:**
 - Inch version:
155%, 129%, 121%
 - Metric version:
141%, 122%, 115%
- ❖ **Zoom:**
From 50% to 200% in 1% steps
- ❖ **Directional Magnification:**
 - Vertical:
From 50% to 200% in 1% steps
 - Horizontal:
From 50% to 200% in 1% steps

❖ **Printing Area:**

- A3 drum:
 - Inch version: More than 290 × 419mm, 11.4" × 16.4"
 - Metric version: More than 290mm × 409mm, 11.4" × 16.1"
- A4 drum:
More than 290mm × 200mm, 11.4" × 7.8"

❖ **Print Paper Size:**

Maximum: 297mm × 432mm, 11.6" × 17.0"
Minimum: 70mm × 148mm, 2.8" × 5.9"

❖ **Leading Edge Margin:**

Less than 10mm, 0.4"



❖ **Print Paper Weight:**

- 47.1 – 209.3g/m², 12.5 – 55.6 lb

❖ **Print Speed:**

60 – 120rpm (5 steps)

❖ **First Copy Time (Master Process Time):**

Less than 15.5 seconds (A3, 11" × 17" )
Less than 12 seconds (A4, 8¹/₂" × 11" )

❖ **Second Copy Time (First Print Time):**

Less than 18.5 seconds (A3, 11" × 17")
Less than 15 seconds (A4, 8¹/₂" × 11")

❖ **Colour Printing:**

Drum unit replacement system (red, blue, green, and brown)

❖ **Image Position:**

- Vertical:
 - Inch version: ± 10mm, ± 0.4"
 - Metric version: ± 15mm, ± 0.6"
- Side:
± 10mm, ± 0.4" (for either side)

❖ **Paper Size and Paper Capacity:**

1,000 sheets (80g/m², 20 lb)

❖ **Paper Delivery Tray Capacity:**

1,000 sheets (80g/m², 20 lb)

❖ **Master Eject Unit Capacity:**

- A3 drum
More than 60 masters
- A4 drum
90 masters

❖ **Dimensions (W × D × H):**

	Width	Depth	Height
Stored	625 mm, 24.6"	650 mm, 25.6"	575 mm, 22"
Stored with document feeder	625 mm, 24.6"	650 mm, 25.6"	684 mm, 26.9"
Set up	1,405 mm, 55.4"	650 mm, 25.6"	575 mm, 22"
Set up with cabinet	1,405 mm, 55.4"	650 mm, 25.6"	1,010 mm, 39.8"
Set up with cabinet and document feeder (when you use A4, 8 ¹ / ₂ " × 11" or smaller paper)	1,215 mm, 47.8"	650 mm, 25.6"	1,120 mm, 44.1"
Set up with cabinet and document feeder (when you use B4, 8 ¹ / ₂ " × 14" or larger paper)	1,405 mm, 55.4"	650 mm, 25.6"	1,120 mm, 44.1"

❖ **Weight:**

- Machine:
Less than 94kg, 207 lb

❖ **Noise Emission *1:**

Sound Power Level

	Mainframe only
During Printing	74dB(A)
Stand-by	47dB(A)

Sound Pressure Level*2

	Mainframe only
During Printing	60dB(A)

*1 The above measurements made in accordance with ISO 7779 are actual value.

*2 It is measured at the position of the bystander.

❖ **Power Consumption:**

- Making a master:
Less than 0.28kW
- Printing:
Less than 0.23kW

❖ **Optional Equipment:**

- Drum unit: colour Drums
A3, 11" × 17"—black, red, blue, green, brown, purple, yellow, navy, maroon, teal, orange, gray, violet, hunter green, burgundy and gold
A4, 8¹/₂" × 11"—black, red, blue, green, brown, purple, yellow, navy, maroon, teal, orange, gray, violet, hunter green, burgundy and gold
- Key Counter
- Document Feeder
- Memory Board
- PC Controller

 **Note**

- ☐ Specifications are subject to change without notice.

Document Feeder (Option)

❖ **Original Type:**

Sheet

❖ **Original Weight:**

40.7 g/m² to 127.9 g/m², 10.8 lb to 34 lb

❖ **Original Size:**

Max. 297 mm × 864 mm, 11.6" × 33.8"

Min. 105 mm × 128 mm, 4.2" × 5.1"

❖ **First Copy Time (Master Process Time):**

Less than 19.5 seconds (A3, 11" × 17")

Less than 16 seconds (A4, 8¹/₂" × 11")

❖ **Second Copy Time (First Print Time):**

Less than 22.5 seconds (A3, 11" × 17")

Less than 19 seconds (A4, 8¹/₂" × 11")

❖ **Original Capacity:**

30 sheets (80 g/m², 20 lb)

4.5 mm, 0.17" height

Sorter (Option)

❖ **Number of Bins:**

40 bins

❖ **Paper Sizes:**

Bins: A3 ☐, B4 ☐, A4 ☐☐, B5 ☐, 11" × 17" ☐, 8¹/₂" × 14" ☐, 8¹/₂" × 11" ☐☐
Paper delivery tray: A3 ☐, B4 ☐, A4 ☐☐, B5 ☐☐, A5 ☐, B6 ☐, A6 ☐, 11" × 17" ☐, 8¹/₂" × 14" ☐, 8¹/₂" × 11" ☐☐, 5¹/₂" × 8¹/₂" ☐☐

❖ **Sort Bin Capacity:**

50 sheets (80g/m², 20 lb)

❖ **Paper Weight:**

52 – 105g/m², 13.9 — 27.8 lb

❖ **Power Consumption:**

144W

❖ **Dimensions (W × D × H):**

900 × 650 × 1,700mm, 35.5" × 25.6" × 67.0"

❖ **Weight**

Approx. 148kg, 326.3 lb

 **Note**

☐ Specifications are subject to change without notice.

Consumables

Name	Size	Remarks
Master:	Length: 110m, 410ft/roll Width: 420mm, 16.5" 2 Rolls/case	A3 drum More than 200 masters can be made per roll A4 drum 330 masters can be made per roll
Ink-Black	1,000ml/pack, 600ml/pack, 5 packs/case	Environmental conditions: -5 to 40°C 10 – 95% RH
Ink-Red	1,000ml/pack, 5 packs/case	
Ink-Blue		
Ink-Green		
Ink-Brown		
Ink-Purple		
Ink-Yellow		
Ink-Navy		
Ink-Maroon		
Ink-Teal		
Ink-Orange		
Ink-Gray		
Ink-Violet		
Ink-Hunter green		
Ink-Burgundy		
Ink-Gold		

 **Note**

- Specifications are subject to change without notice.

INDEX

【◀】【▶】【△】【▽】, 7

- 16 single-sided originals →
 - 1 single-sided print of 16 images, 124
- 1 single-sided original →
 - 1 single-sided print of 2 images, 67
- 1 single-sided originals →
 - 1 single-sided print of 4 images, 67
- 2 single-sided originals →
 - 1 single-sided print with 2 images, 62
- 2 single-sided originals →
 - 1 single-sided print with 4 Images, 62
- 4 single-sided originals →
 - 1 single-sided print of 4 images, 124
- 8 single-sided originals →
 - 1 single-sided print of 8 images, 124

A

- A3/11" × 17" drum indicator, 8
- A3/11" × 17" drum unit, 194
- A4/81/2" × 11" drum indicator, 8
- A4/81/2" × 11" drum unit, 194
- accessing the user tools, 139
- Add Ink Indicator (▲), 189
- adjusting the image density of prints, 25
- adjusting the position of printed images, 24
- All Class mode, 50
- Auto Class, 149
- Auto Class mode, 52
- Auto Combine mode, 67
- Auto Cycle, 49
- 【Auto Cycle】key, 7
- Auto Cycle ON/OFF, 146
- Auto Magnification, 31
- Auto Online, 142
- Auto Quality Start, 75
- Auto Reset, 141
- Auto Rotation, 150
- Auto Separate, 149

B

- Background ON/OFF, 146
- background patterns, 96
- black line/stain, 198

C

- Cancel, 9
- Cancel Comb., 147
- changing the printing speed, 27
- Check Counter, 154, 169
- Chg. User Code, 154, 170
- Class Enter No., 144, 157
- 【Class】key, 7
- Class Manual Set, 146
- Class mode, 60
- Class Sort, 133, 135
- clearing misfeeds, 178
- 【Clear Modes/Energy Saver】key, 7
- 【Clear/Stop】key, 7
- closed area method, 102
- Colour drum, 86
- colour drum, 194
- colour drum indicator, 8
- Colour printing, 86
- combination chart, 137
- Combine, 147
- 【Combine】key, 7
- combine originals, 62
- Combine printing with the document feeder, 83
- combining originals into one print, 62
- combining originals into one print with the memory board, 124
- Comb. Sep. Line, 147
- command sheet, 98
- consumables, 213
- contact glass, 3
- CopyCount Display, 143
- counter, 8

D

- Data Print, 142
- Date Position Set, 152
- Date Stamp, 115
- Date Style Set, 152
- Deflector Angle, 149
- Delivery Capacity, 143
- Del. User Code, 154, 171
- Density(User), 152
- diagonal line method, 101
- Directional Magnification (%), 36
- Directional Magnification (Size), 38
- Direction(Page), 153

dirty background, 196
document feeder (ADF), 4
drum size, 90
drum unit, 3
drum unit handle B2, 87
drum unit lock lever B1, 3

E

Economy mode, 48
【**Economy Mode**】key, 6
Edge Erase, 41
【**Edge Erase**】key, 6
Energy Saver mode, 23
Energy Saving, 142
envelopes, 42
environment, 201
erasing centre and edge margins, 40
erasing edge margins, 41
Exit, 9
exposure glass, 3

F

flip up cover, 1
Form, 113
front door, 1

H

halftone printing, 26
handle E1, 3
having custom messages stamped on prints, 122
having images repeated on one print, 67
having page numbers stamped on prints, 117
having preset messages stamped on prints, 120
having the date stamped on prints, 115
having the machine choose reproduction ratios, 31

I

Idling for Q.start, 148
Ignore Paper Size, 146
【**Image Density**】key, 6
Image Overlay, 113
Image Rotation, 91
indicators, 8
Initial Setting, 144
ink, 189, 213
ink holder, 3
Ink/Master Left, 150

J

Job Separation, 76
【**Job Separator**】key, 6
Jogger, 150

K

Key counter, 5, 194, 210
Key Operator Code, 155
keys, 6

L

Language on LCD, 141
LCD Contrast, 143
Letter mode, 45
Letter/Photo mode printing, 45
Loading Paper, 15
loading paper, 177
Load Paper indicator (📄), 177
Longer Paper, 146

M

machine clearance, 202
machine exterior, 1
machine interior, 2
main switch, 2
maintaining your machine, 204
Make/Chg. Pattern, 153, 168
【**Make-Up**】key, 6
Make-up printing, 105
Make-up printing features, 93
Make-up printing with the optional document feeder, 107
Make-up samples, 110
making master and prints in one operation, 49
Manual Class mode with 2 or more originals, 57
Manual Class mode with one original, 55
Manual Class mode with two or more originals using the document feeder, 84
Manual Quality Start, 75
Margin Eras.Area, 145
master, 191, 213
Master Eject indicator (📄), 193
Master End Indicator (📄), 191
Master length, 78, 150
master misfeed in the master eject section, 184
master misfeed in the master feed section, 182, 183
master tray, 1
Max. Quantity, 143

memory board, 91, 93, 113, 115, 117, 120, 122, 124
Memory Combine, 124
merging images, 113
Min. Quantity, 143
mm/inch, 141
Mode Setting, 146
monitor indicators, 8
MSTR Makg. Density, 144

N

Next, 9
No. of Q.start, 148, 160
No. of Skip Feed, 148, 159
No Orig. Size, 146
No Orig. Size (ADF), 146
Number keys, 7

O

OK, 9
Ppr. Size, 145
【On Line】key, 6
On Line Overlay, 113
On Line printing, 79
Open Cover/Unit Indicator (☐*), 188
operation panel, 1, 6
optional document feeder, 81
options, 4, 210, 211, 212
original misfeed, 185
Original mode, 45
Original Priority, 144
originals, 13, 81
Overlay, 113
【Overlay】key, 6

P

Page Stamp, 117
Panel Beeper, 143
panel display, 8, 9
panel display layout, 10
paper alignment wing knobs, 2
paper alignment wings, 2
paper delivery end plate, 2
paper delivery side plates, 2
paper delivery tray, 2
paper feed side plates, 1
Paper feed side plates knob, 1
Paper feed tray, 1
Paper feed tray down key, 1
paper misfeed in the paper exit section, 182

paper misfeed in the paper feed l section, 178, 179
paper or master wrapped around the drum, 180
Paper Type, 42, 43, 144
PC controller, 79, 113
Pencil mode printing, 47
Photo(Lightness), 144
Photo mode printing, 46
Photo(Screen), 145
platen cover, 3
poor printing, 196
Position(Date), 152
Position(Page), 153
Position(User), 152
power connection, 202
Preset Reduce/Enlarge, 29
Prev., 9
printing confidential documents, 74
printing in two colours, 88
【Print】key, 7
print paper, 11, 42, 177
Program, 71
【Program】key, 7
【Proof】key, 7
protecting a program, 72

Q

【#】key, 7
【Quality Start】key, 6
Quality Start mode, 75

R

R. Counter Display, 141
recalling a program, 72
reducing and enlarging in 1% steps, 34
reducing and enlarging using preset ratios, 29
regaining image density, 75
Reg/Chg KeyOpCode, 155
Regist.(User), 152
Reg. User Code, 154
Remarks, 199
removing program protection, 73
Repeat, 129
repeating an image over the entire print, 124
Reproduction Ratio, 144, 156
Reset Counters, 154, 170
Reset R. Counter, 141
Restricted Access, 155
rotating original images, 91

S

Safety Information, i
saving ink, 48
【Security】 key, 6
Security mode, 74
Select, 9
separating printing sets, 76
service call, 175
Set Operation Mode, 143
Setting Q.start, 148
Setting Up The Paper Delivery Tray, 16
Set User Code, 141
Set User Code(s), 154
Size, 151
Size(User Stamp), 151
【Skip Feed】 key, 6
Skip Feed printing, 69
Sort, 133, 134
【Sorter】 key, 6
special feature indicator, 8
special kinds of paper, 43
specifications, 207
Stamp, 120, 151
Stamp Density, 151
【Stamp】 key, 6
Stamp Position, 151, 162
standard printing, 20
【Start】 key, 7
stopping a multi-print run, 28
storing a program, 71
stretching and squeezing the image in
 1% steps, 36
stretching and squeezing the image
 into the copy area, 38
System, 141

T

thick paper, 42
thin paper, 42
Time Setting, 142, 156
【Tint】 key, 6
Tint Mode, 26
Tint Mode ON/OFF, 145
trailing edge guides, 3
Type, 151
Type of Paper, 150, 161
Type(Page), 152

U

user code, 19, 154
User Stamp, 122
user tools, 139
【User Tools】 key, 6
user tools menu, 141

W

what to do if something goes wrong, 173
what you can do with this machine, vii
when the image density is too light, 198
where to put your machine, 201
【◀】【▶】 keys (Speed keys), 7

Z

Zoom, 34

